

ISSUE 19, September / October 2014
RM10.00

ASIAN TRUCKER

www.asiantrucker.com

MALAYSIA

FEATURE

**Trucks with maximum protection
from Rheinmetall MAN Military Vehicles**

MARKET UPDATE

**HINO Motors officially opens new Malaysian
manufacturing plant at Sendayan**

Cover Story:

Driving the Future at IAA Hannover

SPECIAL REPORT

ZF Keeps the World Moving

**Shell Heavyweight
Challenge Finals in London**

MARKET UPDATE

**ISUZU Malaysia now
offering complete line-up**

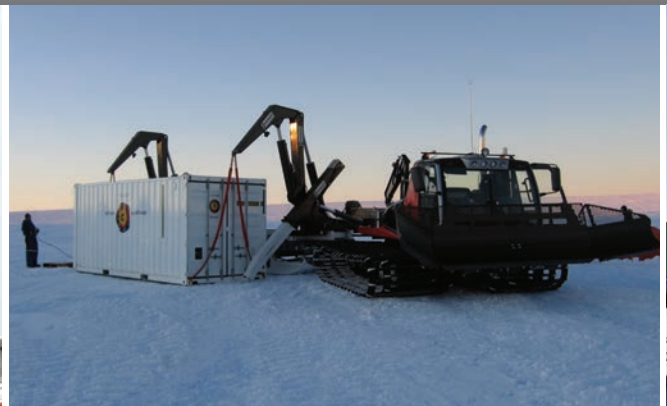

HAMMAR

THE ULTIMATE SIDELOADER

When you want the ultimate sideloader, there is only one choice- HAMMAR.

It can load and cart a 20', 2x20's, a 40', or even a jumbo 45' container in minutes at the push of a button.

Make **HAMMAR** your ultimate choice.

- Lightest tare weight in the world! From 2,000Kgs to 3,000Kgs lighter than the competition. Fuel savings with every kilometer covered!
- 1 tonne to 36 tonnes payload, same cycle time of 3.5 mins! Does not slow down when payload increases.
- 100% Spares always in stock.
- 24hrs back-up service, 365 days all year round.
- PTO or 84Hp Engine Power Pack options

Hammar Malaysia Sdn Bhd
 Port Klang, Malaysia
 Tel: +60 3 3165-6111 Fax: +60 3 3165-1188
 E-mail info@hammar.com.my
 Website www.hammar.com.my

Hammar Maskin AB
 Buagårde 35, SE-517 95 OLSFORS,
 Sweden
 Tel: +46-33 290000 Fax: +46-33 290001
 E-mail info@hammar.eu
 Website www.hammar.eu

Hammar Lift, Inc.
 300 25 Alicia Pkwy # 114 ,Laguna Niguel ,CA 92 677
 Tel: +1 (949) 716-2513 Fax: +1 (949) 716-2514
 Cell: (949) 293-0028
 Email: info@hammarlift.com
 Website www.hammarlift.com



Hammar New Zealand Ltd
 PO Box 72-1347, Papakura 2244, 3 Glasgow Ave,
 Manukau 2104, AUCKLAND, New Zealand
 Tel: +64-9 488 99 80 Fax: +64-9 488 99 84
 E-mail info@hammar.co.nz
 Website www.hammar.co.nz

Hammar Australia Pty Ltd
 PO Box W131, West Pennant Hills, SYDNEY,
 NSW 2125, Australia
 Tel: +61-2 4577 7700 Fax: +61-2 4577 7711
 E-mail info@hammar.com.au
 Website www.hammar.com.au



HINO, THE PROVEN VALUE FOR MONEY BRAND



TRUCK OF THE YEAR 2014

NEW STRAITS TIMES

 **Shell RIMULA**
Heavy Duty Engine Oils



Truck of the Year 2014

Medium Duty Vehicle (10 ton - 18 ton)
3 consecutive years (2012-2014)



HINO MOTORS SALES (MALAYSIA) SDN BHD (187863-U)

Head Office, Selangor: Lot PT. 24, Jalan 223, Section 51A, 46100 Petaling Jaya, Selangor Darul Ehsan, Malaysia. Tel: (603) 7957 5199 (12 lines) Fax: (603) 7954 3276

Branch, Sarawak: Lot 1076, Block 218, 4th Mile, Penrissen Road, 93250 Kuching, Sarawak, Malaysia. Tel: (082) 451 611 (5 lines) Fax: (082) 451 993

Regional Office, Sabah: Mile 4 ½, Tuaran Road, Lot No. 353, Taman Cempaka, Likas, 88450 Kota Kinabalu, Sabah, Malaysia. Tel: (088) 393 663 Fax: (088) 424 223

AUTHORISED DEALERS: ■ **KEDAH** • AWS Jaya Motors 04-731 9706 (Alor Setar), AWS Jaya Motors 04-423 1600 (Sg. Petani), SR Automobile Centre 04-476 6686 (Baling). ■ **PULAU PINANG** • PM Trucks 04-582 3763 (Sg. Bakap), AWS Jaya Motors 04-398 7600 (Seberang Perai), AWS Jaya Motors 04-646 3800 (Bayan Lepas), Sammitr Motors Malaysia 04-502 1458 (Bukit Mertajam), Daihatsu Malaysia 04-397 2151 (Butterworth). ■ **PERAK** • Merge Summit 05-506 2281 (Ipoh), Daihatsu Malaysia 05-527 9000 (Ipoh), SR Automobile Centre 05-434 6000 (Bidor), Merge Summit 05-621 8971 (Teluk Intan), TTJ Agency 05-847 9368 (Taiping). ■ **WILAYAH PERSEKUTUAN, KUALA LUMPUR** • Kee Seong Enterprise (M) 03-9130 8252 (Cheras), International Auto Enterprise 03-9080 4070 (Balakong). ■ **SELANGOR** • Hong Yep Motor 03-6186 3533 (Batu Caves), Eng Kee Commercial Enterprise 03-3374 9278 (Port Klang), Soo Chuan Motor Credit 03-3291 1770 (Jalan Kapar), Daihatsu Malaysia 03-5510 0144 (Shah Alam), Power Truck & Parts 03-8062 6882 (Puchong), Daihatsu Malaysia 03-8943 7235 (Serdang Raya), Daihatsu Malaysia 03-6276 3418 (Kepong), Premium Truck 03-8723 8833 (Kajang), Soon Heng Motors & Commercial Truck 03-3345 2829 (Jenjarom), SR Automobile Centre 03-6021 6007 (Bukit Beruntung). ■ **NEGERI SEMBILAN** • PL Auto Trading 06-767 6699 (Seremban), Edaran Masriaya 06-678 7760 (Seremban), Soon Seng Truck & Parts 06-799 8806 (Nilai), Sembillion Motors 06-454 9999 (Bahau).

Our commitment to providing high **QDR** (*Quality, Durability & Reliability*) products and services makes us stand out again in the industry. We take this opportunity to thank our valued customers for making us who we are today.

HINO is always about **Quality, Durability & Reliability**

HINO
is Value
for
Money



Truck of the Year 2014

Special Mention Awards
Fastest Plant Completion

**36-MONTH
WARRANTY**

or 100,000km

Terms and Conditions apply*

FREE
SERVICE PROGRAM

HINO GENUINE PARTS
ENGINE OIL
LABOR

3 TIMES
Service with every purchase
of HINO LCV 300 Series model

Please browse our website to find your nearest authorised dealer

**24 HOURS
BREAKDOWN SERVICE
FOR TRUCKS**

Applicable to West Malaysia

Toll Free: **1800-88-3666**

*Terms and Conditions Apply

■ **MELAKA** • Paramount Value 06-283 2925 (Melaka), Sam Hin Motors Enterprise 06-286 1939 (Melaka). ■ **JOHOR** • Auto Skyline 07-358 5805 (Johor Bahru), Daihatsu Malaysia 07-224 6601 (Johor Bahru), Key Power 07-236 5188 (Pasir Gudang), Sin Soon Hup 07-557 5533 (Skudai), Smart Edition Auto 07-663 2628 (Kulai), Sam Hin Motors Enterprise 07-931 7939 (Segamat), Daihatsu Malaysia 07-431 5910 (Batu Pahat), Sin Soon Hup Services 06-975 6688 (Muar). ■ **PAHANG** • Minufa Automobile 09-567 6363 (Kuantan), Edaran Riz 09-558 1200 (Kuantan), Teck Lee Motors Agency 09-296 1558 (Temerloh). ■ **TERENGGANU** • Marsing Industries Sdn. Bhd. 019-8866797. ■ **KELANTAN** • K&T Engineering & Trading 09-765 7166 (Kota Bharu), Soon Seng Motors Enterprise 09-748 6837 (Kota Bharu). ■ **SABAH** • Angkatan Hebat Motor 088-389 262 (Kota Kinabalu), Daihatsu Malaysia 088-381 112 (Kota Kinabalu), FF Automobile 088-386 852 (Kota Kinabalu-Menggatal), Edaran ATSB 089-667 178 (Sandakan), Weemaju 089-666 222 (Sandakan), Weemaju 089-881 323 (Lahad Datu), Edaran ATSB 089-888 687 (Lahad Datu), Edaran ATSB 089-772 869 (Tawau). ■ **SARAWAK** • Jong Seng 082-330 066 (Kuching), Lu & Sons Engineering 082-453 737 (Kuching), Rhino Automobile 082-457 775 (Kuching), Lu & Sons Engineering 084-319 373 (Sibu), Jong Seng 086-327 866 (Bintulu), Lu & Sons Engineering 086-334 834 (Bintulu), Jong Seng 085-661 166 (Miri).

AIM FOR CUSTOMER TRUST AND CONFIDENCE



Excelling on the essentials.

UD Trucks focuses on the features and benefits that make your business grow. Benefits such as higher productivity, extended uptime and increased fuel-efficiency. And it excels in it!



TAN CHONG INDUSTRIAL EQUIPMENT SDN BHD (013285-X)

Lot 3, Jalan Perusahaan Satu, 68100 Batu Caves, Selangor D.E, Malaysia. Tel: 03-61899832.
Fax: 03-61899336. Email: enquiry@tcie.com.my Website: www.tcie.com.my
Branches: • Ipoh Tel: 05-2921028 • Johor Bahru Tel: 07-3530300



TCTS Branches: • Bukit Mertajam Tel: 04-5381308 • Kajang Tel: 03-87410537 • Ipoh Tel :05-2923018 • Johor Bahru Tel: 07-3584300 • Batu Pahat Tel: 07-4139887 • Muar Tel : 06-9531300 • Klang Tel: 03-31669609 • Seremban Tel: 06-7623445 • Batu Caves Tel : 03-61850854.
Authorised Dealers: • Combine Motor Sdn Bhd Tel: 03-61363060 • MHK Auto Commercial Sdn Bhd Tel: 03-62587777 • Taycn Kredit Sdn Bhd Tel: 06-6787760 • Commercial Junaction (M) Sdn Bhd Tel: 07-4333998 • Derchin Auto Sdn Bhd Tel: 07-3864108 • Minufa Automobile Sdn Bhd Tel: 09-5669121 • LK Utara Auto Sdn Bhd Tel: 04-7339098



CAMC Heavy-duty Truck, European Standards Definition of new criteria for heavy-duty truck

CAMC new generation heavy-duty trucks are developed by Anhui Hualing Automobile Co. Ltd. by applying world advanced heavy-duty truck technology.

It is powered by high performance common-rail engine with low fuel consumption and high power, complying with Euro III emission standard.



CAMC

DA DEAUTO INDUSTRIES SDN BHD (881055-M)

4x2
6x2
6x4

PRIME MOVER



Engine
Hino P11C- 350Hp
Hino P11C- 380Hp
Cummins ISMe
420-30 -420Hp

Transmission
ZF Friedrichshafen
AG. 9/16 speed

Chassis
Double Layer

Rear Axle
Hub Reduction

6x4
8x4

MIXER TRUCK



Engine
Hino P11C- 350Hp
Hino P11C- 380Hp

Transmission
ZF Friedrichshafen
AG.

Chassis
Double Layer

Rear Axle
Hub Reduction

4x2
6x2
6x4
8x2
8x4

RIGID TRUCK



Engine
Hino P11C- 350Hp
Hino P11C- 380Hp

Transmission
ZF Friedrichshafen
AG. 9/16 speed

Chassis
Double Layer

Rear Axle
Hub Reduction



**KOREA BEST SELLER,
MALAYSIA BEST SAVER.**



SALES DEALER NETWORK

Central (Selangor) : HYUNDAI SIME DARBY MOTORS SDN BHD 03 5191 1433 / CARTRUCKVAN SDN BHD 03 6186 4405/ COMBINE MOTOR SDN BHD 03 6316 8060 / INTERNATIONAL AUTO ENTERPRISE 03 8062 3331 / SOON HENG MOTOR & COMMERCIAL 03 3345 2829 / NCE AUTO TRADING SDN BHD 03 8070 1978 / LEGEND WHEEL SDN BHD 03 5161 5919 / AUTOMATCH 03 3269 8540 / VISTA WHEELS SDN BHD 03 7847 1163 / VICLO MOTOR SDN BHD 03 87332961 / **Central (Kuala Lumpur)** : SUMMIT MOTOR SDN BHD 03 7984 4378 / PTM AUTOMOTIVE SDN BHD 03 6188 6162 / MHK AUTO COMMERCIAL SDN BHD 03 6258 7777 / POWER GENUIS SDN BHD 03 4024 1230 / **Northern**: MAN SOON AUTOMOBILE & ENGINEERING SDN BHD 05 291 9193/ SERIJAYA GEMILANG AUTO SDN BHD 05 321 3881 / HUAN SIN CYCLE MOTOR SDN BHD 04 2826 384 / KOAY ENG CHONG AUTO SDN BHD 04 733 8139 / KUMPULAN



AD3
GVW 5000 KG

AU26
GVW 3600 KG

EDARAN OTOMOBILE M.T.H 04 537 9426 / SAMMITR MOTORS MALAYSIA SDN BHD 04 502 1458 / AUTO VENTURE MOTOR SDN BHD 05 641 5001 / **Southern:** PARAMOUNT VALUE SDN BHD 06 283 2925/ SEREMBAN VICTORY CREDIT SDN BHD 06 761 7711 / ANG TRADING & MOTOR CREDIT SDN BHD 06 955 5525 / SEMBILLION MOTORS SDN BHD 06 764 6666 / GALAXIE MOTOR 016 777 4823 / ULTRA GALLANT SDN BHD 06 677 9903 / HONG YI MOTOR ENTERPRISE SDN BHD 07 772 2929 / SMART EDITION AUTO SDN BHD 07 663 6928 / **East Coast:** BENTONG CAR CENTRE SDN BHD 09 223 3288 / INOTRUCK 09 748 6837 / MINUFA AUTOMOBILE SDN BHD 09 567 6363 / SYARIKAT PERNIAGAAN SRI SEMANTAN SDN BHD 09 296 3288 / **East Malaysia:** RHINO AUTOMOBILE SDN BHD 082 459 444 / RIGHTPOWER AUTOCARE SDN BHD 088 702 222 / LAYAK ASIA SDN BHD 089 770 876 / ISMACO SDN BHD 082 457 322 /

SHACMAN

SUCCESS WITH QUALITY

品质成就未来



**FULLY SUPPORTED BY
OVER 20 BRANCHES
MALAYSIA
24-HOUR RES-Q TEAM**

Northern West Malaysia

**Alor Star, Kedah
Butterworth, Penang
Taiping, Perak
Ipoh, Perak**

East Coast West Malaysia

**Gebeng, Pahang
Kuantan, Pahang
Kuala Terenggan, Terengganu
Kota Bharu, Kelantan**

Central West Malaysia

**Kuala Lumpur
Batu Caves, Selangor
Port Klang, Selangor
Rawang, Selangor
West Port, Selangor**

East Malaysia

**Kota Kinabalu, Sabah
Keningau, Sabah
Miri, Sarawak**

Southern West Malaysia

**Nilai, Negeri Sembilan
Johor Bahru, Johor
Pasir Gudang, Johor
Melaka**

陕汽重卡有限公司

SHAANXI TRUCKS SDN BHD (962614K)



SHACMAN

陕汽重卡

WWW.SHACMAN.COM.MY



Contact Person : Mr.Kau Chez Ching

Tel : +6012-282 2948 / +603-3166 3880

Fax : +603-3166 3770

Email : stsb@yonming.com

Website : www.shacman.com.my

Showroom Address :

Port Klang - Lot 40778, Lorong Gerudi 1, Off Jalan Pelabuhan Utara,

42000 Port Klang, Selangor, Malaysia

Nilai - Lot 9136, Jalan Perak 1, Kawasan Perindustrian Nilai 1,

71800 Nilai, Negeri Sembilan

**FULLY SUPPORTED BY
OVER 20 BRANCHES
MALAYSIA
24-HOUR RES-Q TEAM**



MEMPERKENALKAN **HOWO 8x4 TIPPER**



www.sinotruk.com.my



Space shuttles, aircrafts, military vehicles and race cars all have one thing in common, they have nitrogen in their tyres.



**Malaysia Longest Truck "B-DOUBLE"
now with "TyreBooster" Nitrogen Inflation System**

Why Nitrogen

Oxygen in compressed air permeates through the tyre wall reducing the tyre's inflation pressure. During its journey through the tyre wall, oxygen oxidises rubber compound and deteriorated rubber, thus causing under inflation to increase rolling resistance and shorten tyre life.

Nitrogen is a dry, inert gas with no corrosive properties as found in compressed air, its use to prevent autoignition, maintain longer inflation pressure and help tyre to run cooler. The concept of nitrogen filling in tyre has been known to the industry for many years, it isn't just about improve tyre performance, nitrogen also help to reduce your operation cost. You will discover more surprise when you spend time to find out more about nitrogen tyre inflation for your workshop, your customer or your own vehicle.

Nitrogen Facts - A Competitive Advantages

- Increase 25% more mileages before tread wear
- Nitrogen-filled tyre use less fuel, 3 - 6% increase in fuel efficiency
- Better tyre pressure retention, 4x longer than air
- Reduce tyre running temperature by 20%
- Improve tyre casing retreadability
- Test have shown reduce tyre failures as much as 80%
- Support GO GREEN, reduce CO2 footprint and tyre waste

For more information, please contact:

+603 8060 3388 or visit us at www.tyrebooster.com

OPERATION BY N-FACTORS

An Outstanding Investment - Nitrogen In Tyres

TyreBooster solutions are designed with one essential benefit in mind; to save fleet operator's money. Our solutions are designed to save you over RM5,000 a year per truck and only for a one time investment. Once converted, you will realise the benefits for the life of your tyres.

How You Benefit

- Quick return on investment
- Fuel savings up to 6%
- Increase tyre tread life by 25% , retreads up to 50%
- Reduce tyre failure, less lost revenue due to breakdowns
- Superior retreadability per casing, higher casing value for resale
- Lower accident liability due to fewer blow-outs and collateral accident claims
- Reduce late delivery charges (for guaranteed delivery services)
- Lower costs per km in service for steering tyres, drive tyres, and trailer tyres



Nitrogen Inflation System

Specification

- Capacity : 5 - 30 m³/h
- Nitrogen Purity : 95% - 99%
- Operating Pressure : 100 - 170 PSI
- Inlet/Outlet Port Size : 1/2" BSP
- Dimension (LxWxH) : 800 x 400 x 1400 mm
- Weight : 130 kg

System Features

- Fully automatic start-stop, no power required.
- Plug and play design, easy to use and install.
- Guaranteed >95% purity
- Rugged NEMA 12 (IP55) rated steel enclosure.
- Upgradable for higher capacity
- No moving parts, simple maintenance.
- High quality components installed
- Stainless steel interconnect piping

Auxiliary and Accessories

- Feed air compressor package
- Nitrogen tank
- Nitrogen analyser
- Auto tyre inflator
- Nitrogen valve stem caps

We've got what it takes to get the job done



AT **ANGKA-TAN MOTOR SDN BHD** (85810-A)

No. 5, Jalan 225, Seksyen 51A, 46100 Petaling Jaya, Selangor D. E. Malaysia. Tel : 03-7960 8888 / 3886, Fax : 03-7960 9668 • Butterworth 04-323 0081/73 • Petaling Jaya 03-7960 8888 • Kluang 07-7771318 • Johore Bahru 07-355 3618.

TC TRUCKS SALES SDN BHD :

• Bukit Mertajam : 012-423 2672 • Ipoh : 019-572 0867 • Kuala Lumpur : 012-204 5495 • Klang : 019-335 5125 • Beranang : 016-295 7709 Seremban : 012-639 0309 • Melaka : 012-611 1555 • Muar : 012-681 5432 • Johore Bahru 012-720 3103.

TCIE (SABAH) SDN BHD :

• Kota Kinabalu : 088-425 688 • Sandakan : 089-671 761 • Lahad Datu : 089-884 126 • Tawau : 089-915 115 • Keningau : 089-336 800.

TC MOTOR SARAWAK SDN BHD :

• Kuching : 082-488 811 • Sibul : 084-315 706 • Bintulu : 086-253 911 • Miri : 085-661 667



BISON & AUMAN Trucks



Our Automotive DNA

Our automotive DNA derives from our parent company, Tan Chong Motor Group an established motor company providing transportation solutions in Malaysia's automotive industry for more than 40 years. We make it our business to understand our customers business.

Sales & Service Nationwide

Our nationwide network infrastructure is set up and operating to constantly provide you the support and needs for convenient Service maintenance and Spare Parts assurance in running your business.



Reliable Engineering

Reliable Engineering Technology comes from our business associates namely, Foton-Cummins and Foton-Daimler, both are recognised and renowned Automotive manufacturers proven worldwide in the Trucking Industry.

24 hour Breakdown Service

A fleet of fully equipped RES-Q Mobile Service Team vehicles are on standby twenty four seven plying at all major towns along peninsula Malaysia ready to answer any distress call day or night, 365 days a year. Minimising your vehicle downtime.



An affiliated company of Tan Chong Group

Dealers :

• **Northern Region:** Penang: Koay Eng Chong Auto Sdn Bhd 04-658 8139; Auto Victoria Sdn Bhd 04-508 2333; Perak: Saga Superior Sdn Bhd 05-322 7221; M.L. Su Motor Sdn Bhd 05-693 1660; Hanyang Motors Sdn Bhd 05-848 1888; Kedah: LK Utara Auto Sdn Bhd 04-733 9098 • **Central Region:** Selangor: Membercar Autotruck Sdn Bhd 012-336 2162; Liong Seng & Son Trading Sdn Bhd 03-3374 1998; Power Genius Sdn Bhd 03-5885 0823; Action Wheels Sdn Bhd 03-7847 1198; Element Autolink 03-7772 8363; Titan Machinery Sdn Bhd 012-292 3030; Wang Young Sdn Bhd 03-8070 8896; Combine Motor Sdn Bhd 03-6136 3060; PTM Automotive Sdn Bhd 03-6188 6162; Seremban: Taycn Kredit Sdn Bhd 06-678 7761; Ji-Auto Sdn Bhd 06-632 8418/28; Chia Brothers Enterprise 06-454 2049; Kuala Lumpur: MHK Auto Commercial Sdn Bhd 03-6258 7777; Motor Dynamics 03-7784 2789; NCE Auto Trading Sdn Bhd 03-7773 0093 • **Southern Region:** Melaka: TC Goh Auto Enterprise 06-335 3877/79; PLS Auto Agency 016-313 9221; Paramount Value Sdn Bhd 06-283 2925; Johor: Commercial Junction (M) Sdn Bhd 07-433 3998; Derchin Auto Sdn Bhd 07-386 4108; SK Best Motor 07-241 3101; Lai Heng Auto & Credit Sdn Bhd 06-952 1492; 123 Auto Sdn Bhd 07-236 2299; Wiramas Motor Trading 07-931 7233 • **Eastern Region:** Terengganu: Pengadang Baru Motors Sdn Bhd 09-631 1953; Kelantan: Inotrucks Sdn Bhd 09-748 6837; Pahang: Zep-Zhuan Trading 09-567 6066; Minufa Automobile Sdn Bhd 09-567 6363

CONTENTS



28 EDITOR'S NOTE

MARKET UPDATE

- 30** Coltrac launches new Pirelli tyres in Malaysia
- 32** ISUZU Malaysia now offering complete line-up
- 34** White and Sparkling: Asian Trucker Networking Night
- 36** Palm Oil Transporters to form Association to address woes
- 38** Volvo Trucks Malaysia updates

- 40** Standing the sands of time: Sin Lian
- 42** Exciting events around MIBTC 2015 lined up
- 44** HINO Motors officially opens new Malaysian manufacturing plant at Sendayan. Phase two of project already in progress.
- 46** HINO launches 3S Dealers in Nilai and Temerloh

ASSOCIATE IT

- 48** Johor Sand & Granite Lorry Operator's Association carries the load

Mercedes-Benz Actros provides you with the



Unlimited Mileage* or 2 Years Warranty**

Terms and conditions apply.

For more information, please visit your nearest authorized dealership.

- * For overall vehicle: This warranty covers a period of twelve (12) months inclusive of factory warranty period with unlimited mileage starting from the vehicle registration date of first delivery.
- ** For powertrain (engine, transmission and axle): This warranty covers a period of twenty-four (24) months with unlimited mileage in the first year of operation of mileage. However, the warranty will expire after the vehicle has covered a total of 200,000 kilometers in the second year of vehicle operation starting from the vehicle registration date of first delivery.

CUSTOMERCARE
CENTRE
1-800-88-1133

Mercedes-Benz Malaysia Sdn Bhd (596096-H)
48th Floor, Menara TM, Jalan Pantai Bahru, 50672 Kuala Lumpur.
Tel: 603-2246 8888 Fax: 603-2246 8899 www.mercedes-benz.com.my



Mercedes-Benz

CONTENTS



COVER STORY

- 50** Driving the Future at IAA Hannover
- 52** Brianza Plastica does it both: Continuous and discontinuous laminates
- 53** Scania sets records and heads into new directions with renewable energies
- 54** DOLL sets a new standard for flexibility in heavy loads
- 55** LAMILUX does it again: pushing the boundaries in laminates

- 56** WABCO is the definition of efficient technologies
- 57** HYVA pumps out Innovations
- 58** MAN celebrates clients during Asia Night at IAA

INDUSTRY PROFILE

- 60** Belton Axle Components Sdn Bhd



My job: fleet manager. My choice: LuK clutches.

Choose the highest performance clutch system.

Up to 30%
increased
wear
resistance!



We have redefined longevity.

Our new heavy duty friction lining has a lot to offer! With the new material compound we have achieved an increase of up to 30% in wear resistance and this with premium comfort characteristics. Not only does that sound good, but is unique in the market.

What you can expect:

- Longer service life
- Less downtime
- More efficiency
- Lower costs

This is our offer for your efficiency.

Do you want to know more about the highest performance clutch system? More information at:

www.rexpert.com

Schaeffler Bearings (Malaysia) Sdn. Bhd.

Tel: +603 6275 0620

Fax: +603 6275 6421

Email: LuK-AS.sg@schaeffler.com

www.schaeffler-aftermarket.com



SCHAEFFLER
AUTOMOTIVE AFTERMARKET

CONTENTS



PRODUCT LAUNCH

62 With the new Ford Transit everyone goes further

SAFE ROADS

64 Save your truck from fire with Aces Synergy Engineering's fire suppression equipment

FEATURE

66 Trucks with maximum protection from Rheinmetall MAN Military Vehicles

SPECIAL REPORT

70 Hong Seng Group is big in Penang with Hohan trucks

74 Arrived: on TNT's European Road Network

76 Shell Heavyweight Challenge Finals in London

82 ZF Keeps the World Moving

CRAFT YOUR FUEL CARD TO THE SIZE OF YOUR FLEET



YOUR PARTNER
ON THE ROAD

Please contact us at:

1 300 22 8181

www.shell.com.my

- **CONTROL**
- **CONVENIENCE**
- **SECURITY**
- **SAVINGS**



CONTENTS



88 TRUCK FEATURE

MAN Truck & Bus Middle East



TECH TALK

78 In the business of starting your truck: Yokohama batteries

80 Stay cool with Nanocool

TRUCK FEATURE

88 ISUZU ELF

90 ASIAN TRUCKER DRIVERS CLUB UPDATE

94 CELEBRATE

96 COMMERCIAL VEHICLE FINDER

100 NEWS & NOTES



THE SMARTER MOVE FOR YOUR BUSINESS

Meet the Ford Transit, the world's best-selling commercial vehicle in its class. Cargo or passenger van, the Ford Transit is not only a powerful and reliable asset. But it's also the economical choice to match your business needs. And like all smart businesses, these multiple-international-award-winning vehicles are backed by a solid network of Ford Commercial Vehicle Centres nationwide.

From SMEs to large multinational corporations, the Ford Transit has been hailed the backbone of business operations. Just ask the 7 million Ford Transit drivers worldwide!

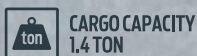
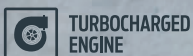

Available in 2 models:
 • 13-seater Window Van
 • 1.4 Ton capacity Panel Van

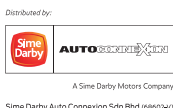

Authorized Ford Commercial Vehicle Centres: KUALA LUMPUR Ampang Tel : 03-4251 8322 • SELANGOR Petaling Jaya, Federal Highway Tel: 03-7718 1200 • Damansara Tel: 03-7728 6699 • JOHOR Johor Bahru Tel: 07-331 6388 • Muar Tel: 06-952 1537 • NEGERI SEMBILAN Seremban Tel: 06-762 9067 • PERAK Ipoh Tel: 05-529 3989 • PAHANG Kuantan Tel: 09-514 8911 • SARAWAK Sibul Tel: 084-215 865
 Image shown may vary from actual vehicles.



Go Further

ford.com.my
 1 800 38 3181

The Drivers.

ASIAN
TRUCKER

EDITORIAL

Editor

Stefan Pertz

Writer

Fajar

Graphic Designer

Eng Chuan

Photographers

Floyd Cowan
Eng Chuan

Contributors

Floyd Cowan

Advertising

Nicole Fong
Nicole@asiantrucker.com

SINGAPORE

Floyd Cowan
Floyd@asiantrucker.com

THAILAND

Songyot Kamontavikun
Songyot@asiantrucker.com

CIRCULATION, CONTRIBUTIONS and SUBSCRIPTION

info@asiantrucker.com
WEBSITE and E-NEWSLETTER
www.asiantrucker.com

PUBLISHED BY

ADAIKALARAJ MEDIA GROUP SDN BHD
The Penthouse, No 1-3A, Jalan PJU 8/3,
Damansara Perdana, 47820 Petaling Jaya,
Selangor, Malaysia
www.amg.com.my

ARTICLE

Asian Trucker is a registered trademark of Asian Trucker Media Sdn Bhd. All articles submitted for publication become the property of the publisher. The editor reserves the right to adjust any article to confirm with the magazine format.

Asian Trucker is a quarterly publication. The publisher will not be responsible for any copyright violation of articles that have been approved by contributing writers. The publisher accepts no responsibility for unsolicited manuscripts, illustrations or photographs.

PRINTED IN MALAYSIA

Percetakan Osacar Sdn Bhd
(Co.Registration : 63461-W)
Lot 37659, No 11, Jalan 4/37A,
Taman Bukit Maluri Industrial Area
Kepong, 52100 Kuala Lumpur

Distributed by

MPH Distributors Sdn Bhd (5048-A)
Ground Floor Warehouse, Bangunan TH
No 5, Jalan Bersatu Section 13/4
46200 Petaling Jaya
Selangor Darul Ehsan Malaysia

Boost your business with a listing on our new website.
Find businesses or sell your truck, upload your events or images to the gallery.
Visit our new website www.asiantrucker.com to put your company on speed.

Consistently Efficient

German engineering at its best



DRIVING IS NOW MORE EFFICIENT WITH MAN

Innovative engines get more kilometers out of every liter of fuel.

In long-haul transport, commercial vehicles must be as fuel-efficient as possible. MAN's Trucks and Buses are designed that way.

Efficient economy needs smooth-running mobility. That's where maintenance comes in.

To ensure our customers get the best after-sales service for smooth-running mobility, MTBM has opened the MAN Truck And Bus Service Johor Bahru.

Come visit our new service centre and see MAN vehicles at:

12A Jalan Kencana Mas 2,
Kawasan Perindustrian
Tebrau 3
81100 Johor Bahru
Tel : 017 - 884 5910

Engineering the Future – since 1758.
MAN Truck & Bus (M) Sdn. Bhd. (224536 - W)
Lot 4, Jalan Industri 3/2,
Taman Industri Integrasi Rawang
48000 Rawang, Selangor Darul Ehsan.

T • 603 - 6092 6977
F • 603 - 6092 6966
W • www.man.com.my





stefan@asiantrucker.com

Asian Trucker on European Tour

Once again it was time for IAA, the world's largest commercial vehicle exhibition, held biannually in Germany. Which meant that we went to seek out the latest in trucking so that we could tell you about recent developments and product updates. For me, it was also an opportunity to visit not only my hometown, but also other familiar and interesting places. The Asian Trucker team had a good time in Autostadt (My fourth time there) and other places. We sent Fajar to London to meet the Heavyweight Challenge finalists, Nicole explored Hannover and I nipped over to Holland to meet with TNT at their headquarters. Meanwhile, Floyd was busy watching gauges at Volvo's Fuel Watch global final in Sweden. It seemed that the entire Asian Trucker crew had relocated to Europe. All of this you will find in the Asian Trucker issue you are about to read.

Back home

Although not such a mega-event as IAA, the fourth instalment of our Asian Trucker Networking night was attended by a great crowd and I enjoyed catching up with many of you. It is always good to get people out of the office and to have a leisurely chat over pub grub. I am already looking forward to the next Asian Trucker Networking Night, which will be held on 15 May during MIBTC. Yes, I am German and we like to plan things way ahead. But no worries, we will send out invites in time to remind you!

In an earlier issue I wrote about the continued growth of the region and we can see that South East Asia's trucking industries are still growing. I am happy to say that I can't make it to all events anymore as there is a lot going on and sometimes happenings overlap.

Worrying observation

One negative I would like to highlight though is the perception of truck drivers in Malaysia. Recently I followed a Facebook conversation on this topic. The tread literally condemned all truckers to be rude, rowdies of little, if no, education. I asked who is responsible for this perception as many truckers we meet are decent people who work hard and drive carefully. It is a few bad apples that spoil it for everyone was my conclusion.

However, the few bad apples are enough to create the impression that this industry is unsafe, that drivers have no manners and bosses don't care. What I would hope to see is peer-pressure. My wish is that the good operators point at the bad ones and demand change in behaviour and attitude. That they set standards that all are expected to uphold. Only then will we repair the image of truckers. Yes, drivers of passenger cars also can be reckless, but let's clean up our act first before we point fingers.

Gearing up

With about half a year until MIBTC 2015 it is time to gear up for this event now that we are back from IAA. For exhibitors we have a few very exciting ideas: Best Booth Award and Business Matchmaking. I was amazed by some of the booths last year and I cannot wait to see the stunning creations some of you will come up with.

Drive safe, don't overtake on emergency lanes,

Stefan

Editor, Asian Trucker Malaysia



Scania Total Solutions - optimised for your best profitability.

With over 100 years of experience in over 100 countries globally, Scania's wide range of industrial solutions offer the highest level of performance, safety, fuel economy, reliability and robustness. With Scania's superior driver training and after sales service, we can optimise your operations for the best profitability.

Trucks

Able to handle long-haulage, distribution, construction and special purposes, our trucks cover your every need.

Bus and Coach Chassis

Our dedication to passenger comfort makes every city or intercity journey an enjoyable one.

Marine, Industrial and Power Generation Engines

Features powerful technology and flexible customer options to power up your business.

Services

We are located in 10 Scania owned and operated service centres across Malaysia, providing scheduled maintenance, parts services and contracted services for maximum uptime. No matter the time, location or need, our service teams are always accessible with our 24/7 roadside assistance and mobile service vehicles for difficult-to-reach areas.

Scania Credit

Value and flexibility of diversified financial solutions from hire purchase to insurance with your profitability in mind.

Call us at +60 3 7845 1000 and speak to one of our consultants. For more information on our network of branches and after sales service centres, please visit our website.



Coltrac launches new Pirelli tyres in Malaysia

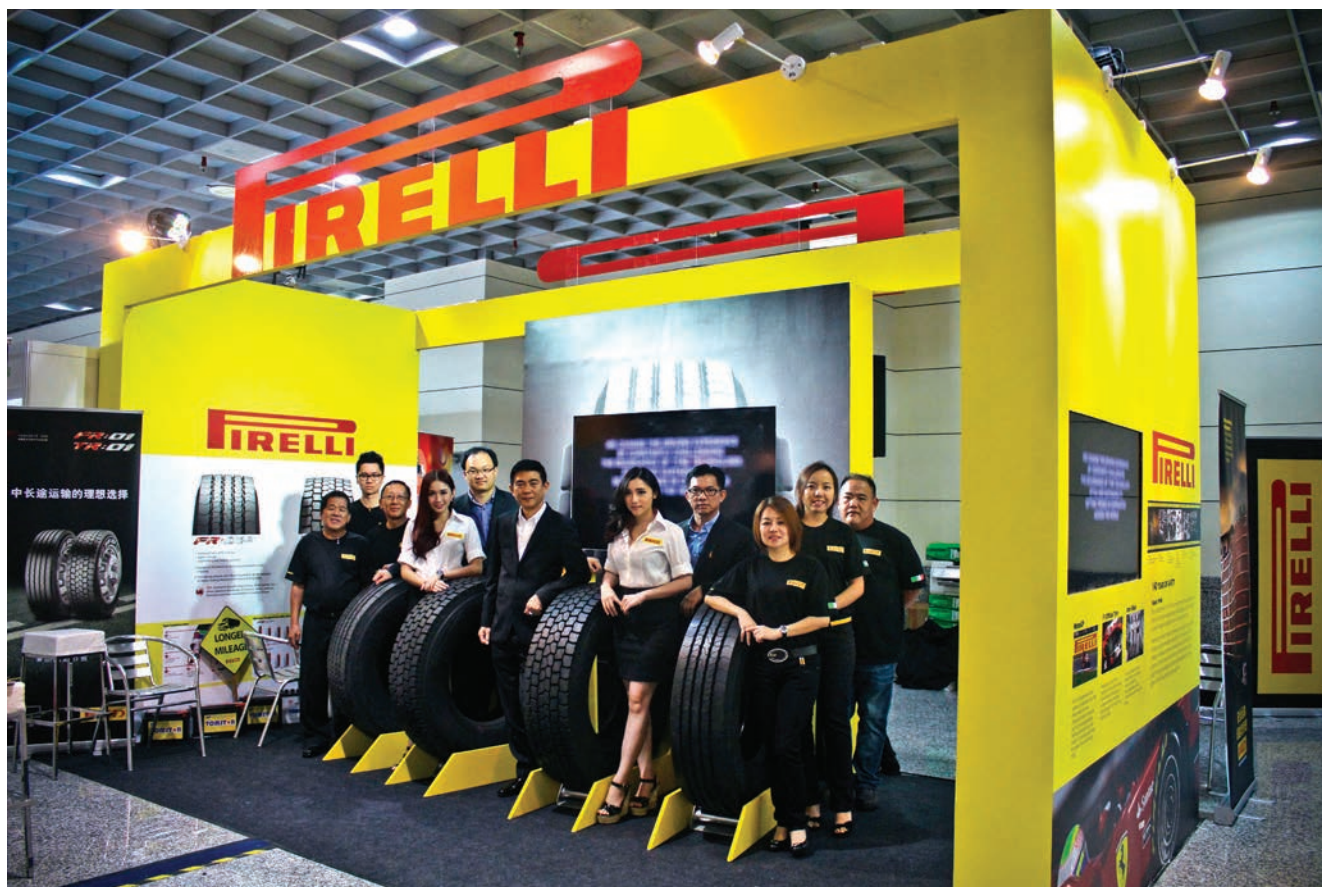

Pirelli together with their Truck & Bus Sole Distributor for Malaysia, Coltrac Sdn Bhd launched the latest generation of truck and bus Tyre which is FR01 II and TR01 II at the recently concluded MAI - LAFARGE Automotive & Logistic Safety Exhibition 2014. These tyres are meant for regional application. Pirelli and Coltrac Sdn Bhd took the opportunity to introduce to Lafarge Malaysia's official transporters across Malaysia the latest generation of Pirelli tyres, namely the FR01 II and TR01 II. These had been launched earlier in other countries across Asia Pacific and now in Malaysia. Malaysia is the first ASEAN country in which this latest generation Pirelli truck and bus Tyre is launched.

Pirelli & C SpA, well known as the Italian tire giant, has made significant investment to make China its largest global manufacturing centre in Pirelli. According Gregorio Borgo, CEO of Pirelli Asia Pacific, the expansion is necessary to keep pace with the huge potential market for its tires. This stems from China's surging demand for luxury and sports-utility vehicles. Gergorio

Borgo continues to say that "By 2014, Pirelli manufacturing base in Yanzhou, Shandong province, which is the only one in Asia-Pacific, will become the biggest in the world for Pirelli".

PIRELLI expects an average annual growth of 16 percent in Asia Pacific over the next three years as the Italian tire maker seeks to strengthen its leadership in the premium segment which include truck tires. The region, where sales rose 14.5 percent to nearly 500 million Euros (US\$692 million) in 2013, or 8 percent of its global total, is already Pirelli's fastest growing market. By 2016, Asia Pacific sales could reach 770 million Euros, according to regional CEO Carlo Costa Ardissone.

These new tires focus on two key features, which are Safety and Durability.

SAFETY: 10% better road holding on dry and wet road

DURABILITY: 20% more mileage in ensuring longer lasting for FR01 II and 10% more mileage in ensuring

longer lasting for TR01 II

DURABILITY: 10% better resistance to tread tyres FR01 II and 20% better resistance to tread tyres for TR01 II

DURABILITY: 10% on casing durability for better retreadability both for FR01 II TR01 II

The new tread compound formula and the high content of silica ensure high mileage and resistance to the stress typical of tires intended for mixed use, even on moderately abrasive surfaces. Performance in dry and wet conditions is improved whilst maintaining high safety levels for the entire life of the tyre. Groove and siping geometry is designed for steering precision and progressiveness combined with great road holding on a variety of surfaces.

"With the launch of the new tire, we aim to work closely with Coltrac Sdn Bhd to establish Pirelli Truck & Bus Tire in the Malaysia market with the right Area Distributor" a statement from Pirelli read. 



In conjunction with the 10th anniversary, we are offering
EXTRA CASH REBATE RM2,000*
 per unit.
 For a limited time only. Hurry and visit your nearest dealership!

10th Anniversary Celebrating 10 years of Mercedes-Benz Malaysia being an authorized distributor of FUSO trucks

BUY A FUSO TRUCK

And Stand A Chance To Drive Away With A

Mercedes-Benz C200*

And Holiday Vouchers Worth RM430,000

2 MINI DRAWS IN 2ND* & 3RD* QUARTER OF 2014

*Trucks registered between 1st December 2013 and 31st March 2014

**Trucks registered between 1st December 2013 and 31st July 2014

Rank	Prize x	Prize	Value
1st	Prize x 1	Holiday Voucher	RM20,000
2nd	Prize x 1	Holiday Voucher	RM10,000
3rd	Prize x 1	Holiday Voucher	RM5,000
Consolation	Prize x 10	Service & Parts Voucher	RM1,000

YEAR-END GRAND FINAL DRAW 2014!

*Trucks registered between 1st December 2013 and 30th November 2014

Rank	Grand Prize x	Prize	Value
1st	Grand Prize x 1	Mercedes-Benz C200	
2nd	Prize x 1	Holiday Voucher	RM20,000
3rd	Prize x 1	Holiday Voucher	RM10,000
4th-10th	Prize x 7	Service & Parts Voucher	RM5,000
Consolation	Prize x 10	Service & Parts Voucher	RM1,000

MITSUBISHI FUSO Authorized Service Dealer 1S (Sales), 3S (Sales & Service)

KLANG VALLEY

Kinta Karisma Sdn Bhd, Petaling Jaya (1S) Tel: 03 7957 8006
 Luton Trading Sdn Bhd, Shah Alam (1S) Tel: 03 5524 1662
 Mimufa Automobile Sdn Bhd, Kepong (1S) Tel: 03 6250 3636
 Power Genius Sdn Bhd, Rawang (1S) Tel: 03 6091 7559
 Vicdo Motor Sdn Bhd, Kajang (1S) Tel: 03 8733 2961
 Vista Wheels Sdn Bhd, Shah Alam (1S) Tel: 03 7847 1163
 Wang Young Sdn Bhd, Puchong (1S) Tel: 03 8070 8996
 International Auto Sdn Bhd, Puchong (1S) Tel: 03 8062 3331
 Bumi Asia Auto Sdn Bhd, Badakong (3S) Tel: 03 8736 1201
 Hap Seng Star Sdn Bhd, Kinrara (3S) Tel: 03 8073 3888
 KK Truck (M) Sdn Bhd, Klang (3S) Tel: 03 3345 2829
 PTM Automotive Sdn Bhd, Batu Caves (3S) Tel: 03 6188 6162
 TRI Motor Enterprise Sdn Bhd, Klang (3S) Tel: 03 3341 9061
 Lean Brothers Truck & Machinery Sdn Bhd, Sabak Bernam (3S) Tel: 03 3216 4113

NEGERI SEMBILAN

CE Distributions Sdn Bhd, Seremban (1S) Tel: 06 762 8899
 Sembillon Motors Sdn Bhd, Seremban (3S) Tel: 06 764 6666

MALACCA

Paramount Value Sdn Bhd, Melaka (1S) Tel: 06 283 2925

KEDAH

Koay Eng Chong Auto Sdn Bhd, Alor Setar (1S) Tel: 04 733 8139

TERENGGANU

Pengadang Baru Motors Sdn Bhd, Kuala Terengganu (3S) Tel: 09 631 1953

JOHOR

N.K Automobile Sdn Bhd, Johor Bahru (1S) Tel: 07 237 7733
 Sagito Motor (M) Sdn Bhd, Johor Bahru (1S) Tel: 07 237 2000
 Sin Soon Hup Services Sdn Bhd, Muar (3S) Tel: 06 975 6688

KELANTAN

Leang Seng Motors (1980) Sdn Bhd, Kota Bharu (3S) Tel: 09 748 1351

PAHANG

Minufa Automobile Sdn Bhd, Kuantan (1S) Tel: 09 567 6363
 Syarikat Perniagaan Sri Semantan Sdn Bhd, Temerloh (3S) Tel: 09 296 3288

PENANG

Huan Sin Cycle Motor Sdn Bhd, Bayan Lepas (3S) Tel: 04 626 6342
 Kee Huat Auto Sdn Bhd, Penang (3S) Tel: 04 626 5031
 Koay Eng Chong Auto Sdn Bhd, Penang (1S) Tel: 04 658 8139
 Grand Mitsu Commercial Veh Sdn Bhd, Butterworth (1S) Tel: 04 356 2669
 Kumpulan Edaran Otomobil M.T.H (M) Sdn Bhd, Bukit Mertajam (1S) Tel: 04 539 7088

PERAK

Serijaya Gemilang Auto Sdn Bhd, Ipoh (1S) Tel: 05 321 3881
 Man Soon Automobile & Eng Sdn Bhd, Chemor (3S) Tel: 05 291 9193

SABAH

Hap Seng Star Sdn Bhd, Kota Kinabalu (3S) Tel: 088 435 043
 TBNC Motor Sdn Bhd, Kota Kinabalu (3S) Tel: 088 222 322
 TBNC Motor Sdn Bhd, Tawau (3S) Tel: 089 762 599
 TBNC Motor Sdn Bhd, Sandakan (3S) Tel: 089 217 888

SARAWAK

Sin Young Huat, Kuching (3S) Tel: 082 363 836
 Hap Seng Star Sdn Bhd, Kuching (3S) Tel: 082 333 460



3 FREE SERVICES	Up to 20,000km*	100,000km OR 3 YEARS WARRANTY** LIGHT DUTY TRUCK	80,000km OR 2 YEARS WARRANTY** HEAVY DUTY TRUCK
		MERCEDES-BENZ SERVICES MALAYSIA provides automotive financing and insurance solution for FUSO trucks. Contact our finance & insurance Customer Service Centre at 1-800-22-6237 for more information.	

*For more information, please contact your nearest dealership. For full prize list and terms and conditions, please visit www.mitsubishi-fuso.com.my

Mercedes Benz Malaysia





ISUZU Malaysia now offering complete line-up

With the GIGA and additional models of the FORWARD series now launched in Malaysia, Isuzu is able to cover the entire spectrum of transportation needs, aiming to further increase market share.

Isuzu Malaysia now offers a complete line-up of trucks to meet the growing demand for high-quality, dependable and fuel efficient trucks following the launch of its new Isuzu GIGA range of heavy duty rigid trucks and prime movers on September 5th in Setia Alam. The company also updated its Forward range by adding two variants in the 11-ton GVW and 16-ton GVW range.

With its introduction, Isuzu Malaysia is now able to offer Malaysian business operators with an array of its hard-working trucks in all segments ranging from the light-duty Isuzu ELF series to the medium-duty Isuzu FORWARD series and now, the heavy duty Isuzu GIGA series of trucks.

Speaking at the launch, Director & Senior General Manager of Isuzu Malaysia Katsuro Ishihara noted that the introduction of the new Isuzu GIGA trucks was an important step forward by the company in an effort to offer customers with full range of Isuzu products.

“Isuzu’s reputation as a producer of top-quality dependable and efficient trucks has been the cornerstone for its global success. Particularly here in Malaysia where it has been the top-selling truck brand in the light duty segment for four consecutive years, our customer demands are growing for a wider range of trucks to meet their individual needs,” said Ishihara.

The Isuzu GIGA family will offer two variants in the prime mover segment, the Isuzu GIGA PRIME 18-ton truck with a 4x2 drivetrain and a 23-ton truck with a 6x4 drivetrain. These trucks are the result of the latest Isuzu design concept based on the 700P platform, giving the new GIGA its handsome and strong stance while providing the cutting-edge aerodynamics, ergonomics and safety standards.

Powered by the turbocharged and intercooled common rail 6-cylinder 6UZ1-TCC powerplant, the Isuzu GIGA offers impressive hauling performance with 360PS and a whopping 1,422Nm of torque on tap.



Apart from the prime mover, the GIGA range will also include a 6x4 rigid truck designed for haulage in extreme conditions. The FXZ 360 uses the same engine as the Isuzu GIGA PRIME models and also feature the same nine-speed ZF gearbox to put power to the ground more effectively.

To provide more customized solutions to individual customer requirements, Isuzu Malaysia further introduced additional variants to the Isuzu FORWARD series. Starting with Isuzu FSR PRO, this narrow cab 11-ton GVW bridges the gap to the smaller light-duty Isuzu ELF models by offering greater tonnage for intra-urban haulage. It even uses a 4-cylinder powerplant making the truck less bulky and more efficient around city streets.

Joining the FSR PRO in the Isuzu FORWARD line-up is the FVR PRO, a truck that shares the same engine but with a longer wheelbase and a bigger 16-ton GVW. The two new variants will join the current line-up of FVR models in the 18-ton category which topped the sales charts in 2013. **F**



OUT OF AFRICA RESTAURANT AND KUDU BAR.



White and Sparkling: Asian Trucker Networking Night

Held for the fourth time, the Asian Trucker Networking Night sees great attendance from the industry, with participants donating 3000 RM for a good cause.

Premium Sponsor



SINOTRUK MALAYSIA SDN BHD

DJ Sponsor



Tyre Sponsor



For the fourth time running, the Asian Trucker Networking Night brought together industry players for a great night of fun, business discussions and for the first time a donation drive. Over 100 leaders from the industry dressed in white and converged to celebrate trucking, making this event yet another success.

“Appreciate your introduction” was a phrase we heard many times during the

night. Thanks to the Asian Trucker team, many made new connections during the night and we are certain that talks continued on the following days.

During the evening Asian Trucker organised a donation drive, the first ever. “We have chosen a foster home in need of support and we will organise more such initiatives in the future” said Stefan Pertz during the event. A total of 3 000

RM was raised during the night and handed over to “Rumah Titian Kaseh” the following week.

Asian Trucker expresses its sincere thanks for the donations and for the support of the sponsors for the event, namely Sinotruk Malaysia as headline sponsor, Kit Loong and ITG. The next Asian Trucker Networking Night will be held on 15 May 2015 during MIBTC. **T**



ISUZU

INTRODUCING THE ALL-NEW ISUZU FORWARD AND GIGA



ISUZU FORWARD (Medium Duty Truck) and GIGA (Heavy Duty Truck) are the top choice of the businesses around the world. Renowned for high performance and reliability, they are built tough and fuel-efficient to drive your business forward. For further enquiries, contact your nearest authorised dealer today.

Reliable support with
round-the-clock
business operation.

1-800-88-8000



ISUZU MALAYSIA SDN BHD (664946-H) HOTLINE: 1-300-88-1133 WEBSITE: www.isuzu.net.my

Peninsular Malaysia Authorised Dealers: **KEDAH** • Indah Utara Auto Sdn Bhd (Alor Setar) - 04-735 1111 • Indah Utara Auto Sdn Bhd (Sungai Petani) - 04-431 8788 **PULAU PINANG** • ACM Sdn Bhd (Prai) - 04-501 1888 • Indah Utara Auto Sdn Bhd (Bukit Mertajam) - 04-530 0555 **PERAK** • ACM Sdn Bhd (Ipoh) - 05-318 8000 • Weng Fatt Otomobil Sdn Bhd (Ipoh) - 05-254 0992 • Weng Fatt Otomobil Sdn Bhd (Sitiawan) - 05-691 8996 **KUALA LUMPUR** • Metro Otomobil Sdn Bhd (Kepong) - 03-6251 7319 **SELANGOR** • ACM Sdn Bhd (Batu Caves) - 03-6188 1133 • ACM Sdn Bhd (Shah Alam) - 03-5513 0160 • Continental Top Motors Sdn Bhd (Seri Kembangan) - 03-8942 7010 • Motor Uniforce Sdn Bhd (Petaling Jaya) - 03-7784 2789 • PTM Accel Sdn Bhd (Sungai Buloh) - 03-6188 6162 • SV Prestige Auto Sdn Bhd (Balakong) - 03-9082 1112 • VS Automotive (M) Sdn Bhd (Rawang) - 03-6093 6995 **NEGERI SEMBILAN** • Ultra Gallant Sdn Bhd (Seremban) - 06-677 9903 **MELAKA** • Ng Hup Lee Motors Sdn Bhd (Peringgit) - 06-283 4755 **JOHOR** • ACM Sdn Bhd (Johor Bahru) - 07-352 1333 • Jumbo Arena Sdn Bhd (Batu Pahat) - 07-435 5666 • Key Power Motor Sdn Bhd (Johor Bahru) - 07-333 6953 **PAHANG** • ACM Sdn Bhd (Kuantan) - 09-512 6868 • Dynamic Motors Sdn Bhd (Kuantan) - 09-566 8898 • Pacific Motor Sdn Bhd (Temerloh) - 09-290 1722 • Pacific Motor Sdn Bhd (Raub) - 09-355 8577 **KELANTAN** • T.E.C. United Auto Sdn Bhd (Kg Tapang, Kota Bharu) - 09-764 8385 • T.E.C. United Auto Sdn Bhd (Taman Maju, Kota Bharu) - 09-748 5888 **TERENGGANU** • Yeow Lee Commercial Sdn Bhd (Kuala Terengganu) - 09-622 6758

East Malaysia Authorised Dealers: **SABAH** • Universal Motor Sdn Bhd (Kota Kinabalu) - 088-388 920 • Universal Motor Sdn Bhd (Tawau) - 089-775 500 • Universal Motor Sdn Bhd (Keningau) - 087-335 505 **SARAWAK** • KM Mobil Sdn Bhd (Bintulu) - 086-318 668 • KM Mobil Sdn Bhd (Miri) - 085-659 595 • Rhino Motors Sdn Bhd (Kuching) - 082-452 444 • Rhino Motors Sdn Bhd (Sibu) - 084-344 444

Palm Oil Transporters to form Association to address woes



Held for the first time, a gathering of palm oil transporters sees over 20 companies joining hands to form an association in order to give the industry a common voice.

It was the first time such gathering happened for the palm oil transporters and organiser Sidhu Brothers were happy with the participation. Jimmy Sidhu stressed that although Sidhu Brothers are organising the event they are not representing the industry or are intended to be the main beneficiary of the event “We simply want to take a step forward to improve our industry. We only facilitate”, Jimmy Sidhu told us in a conversation prior to the event.

“If others have associations to represent their industry, there is no reason why we can’t do the same. After all, palm oil is the second biggest contributor to Malaysia’s GDP”, one participant present said. In total, there are over 3 000 tanker trailers in Malaysia moving palm oil. According to the palm oil transporters, there are many issues that need to be addressed. Palm Oil Theft has now moved from operations in hot-spots to hi-jacking of entire trailers. Participants at the gathering reported that on average two complete trailers filled with palm oil are being hijacked per month. In August, three tanker trailers were stolen.

Rising cost and issues with discrepancies of deliveries are additional problems that were mentioned. The latter stems from the fact that weighbridges are not calibrated or monitored by independent bodies. Every tanker is weighed at each mill (loading)and refinery (unloading). The shortage is contributed from;

A)weighbridge variances, mill & refinery weighbridge inaccuracy
 B)tanker skin losses c)drivers pilferages. These variances are borne by the transporter. The allowance of only 40Kg is too small according to the group that met.

Apparently, several palm oil mills do not have proper loading bays. These bays are too narrow, making it difficult and therefore dangerous to maneuver tankers into the bays. In certain places roads into palm oil estates haven’t been upgraded to cater to the heavier trucks. Nowadays, trucks move some 35mt as compared to 15mt decades ago. Such roads are unsafe to use. Congestion at palm mills adds to the issues the transporters are facing.



Driver shortages were also a major problem. As one participant asked “Why can’t we hire foreigners if the government is not putting in place programs to encourage people to become drivers. There should be vocational training

programs to educate young people, allowing them to earn money as truck drivers”. It was mentioned by Asian Trucker that strategic partner TUEV Rheinland offers vocational training to be commercial vehicle drivers are offered in Germany. In connection with this, the issue of criminal drivers was also raised. There is currently no system that allows employers to check the past record of drivers.

The AFTA and its ramifications for the industry were a key topic in connection with rising cost, competitiveness of the industry and the driver shortage. During the meeting, industry players were urged to start reading up on the opportunities and threats that the AFTA brings about.

At the end of this successful initial gathering it was concluded that an association is to be set up for the industry in order to represent this important industry segment of the transport industry. As there is currently there is no standard or guideline by MPOB/PORAM on the matter of shortages during deliveries this will be the first issue to be addressed. FOSFA international (Federation of Oils, Seeds and Fats Associations) has guidelines for international shipping tanker at 0.5% is set as permissible allowance. The group of palm oil transporters that gathered is proposing a similar guidelines by MPOB who actually licenses them. **T**



Fifth Wheel Coupler



King Pin



Landing Gear

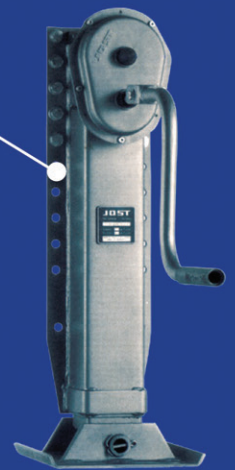

ALL KIND OF WINDSCREEN FOR TRUCKS & CARS



Hydraulic Tipping Hoists

Edbro

Leading the market with product developments ever since 1916

Member of **JOST**-World

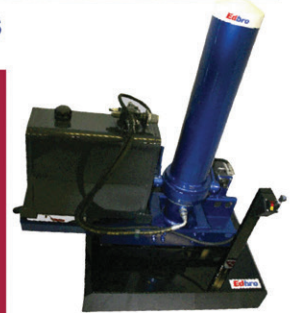

HYDRAULIC PUMP

Bend-Axis Pump



Iso Gear Pump

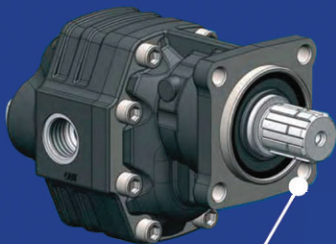

Buffulo Mobile Batching Plant Uses JOST Landing Gear & TKK Trailer Component



U-LI AUTO PARTS & SERVICE SDN.BHD

(350857-M)

NO. 54, JALAN BESI, BATU 3 1/2, OFF JALAN SUNGAI BESI, 57100 KUALA LUMPUR. W. MALAYSIA.

TEL: 603-7980 8429 / 7980 8430 / 7980 8431 / 7984 3428 / 7983 8428 FAX: 603-7980 8433 E-MAIL: uliauto@gmail.com



Volvo Trucks Malaysia updates

Recently, a lot of movement happened in Volvo Trucks Malaysia.



The management of Volvo Trucks Malaysia is pleased to announce the promotion of Mr. Lim Hock Choon to Dealer Manager of Bintulu and Sibul, effective 1st July 2014. He will be reporting to Mr. Alex Yong, General Manager – East Malaysia.

Also, Volvo appointed Ms. Irene Kang as Admin and Parts Sales Manager for Sibul, effective 1st July 2014. She will be reporting to Mr. Lim Hock Choon, Dealer Manager of Bintulu and Sibul.

It was further announced that the new General Manager for Central Region will be Gunasekaran Muthu who previously held the Dealer Development Manager

position in VM's HQ. He will assume the position as General Manager Central Region for all Trucks and Bus after market activities. Laurent Lyonnet, who previously held the position of General Manager Central Region will be taking over the Dealer Development Manager role in the HQ level.

Staff Transfer

Ms. Lydia Michael Padi, Service Clerk, will be transferred from Bintulu to Sibul, effective 1st July 2014. She will be reporting to Mr. Lim Hock Choon, Dealer Manager of Bintulu and Sibul.

Mr. Herryson Benedict, Mechanic II will be transferred from Bintulu to Sibul, effective 1st July 2014. He will be reporting to Mr. Ho Khee Jeow, Workshop Supervisor of Sibul.



Mr Aldrin Wilfred, Mechanic I will be transferred from Sibul to Kuching, effective 1st October 2014. He will be reporting to Mr. Gordon George, Service Supervisor of Kuching.

Dealerships

The Volvo Sibul dealership can now be found in its new location and new address from 8 Aug onwards:

N0 8, Lorong Then Kung Suk 3A1
96000 Sibul, Sarawak
Tel: 084-210 613
Fax: 084-210 612

From a shop lot, the dealership has now moved into a stand-alone building which is bigger and well equipped with the latest tools. 



**Value-for-money, performance, reliability,
power, fuel economy, return-on-investment,
workhorse, low operating costs, bottom-line, peace-of-mind,
durability, efficiency, business advantage, profits,
productivity...**

**If these are important questions you think about all the time,
there is a truck with all the answers**

Dongfeng Kinland 375, 4x2 prime mover



DONGFENG COMMERCIAL VEHICLE (MALAYSIA) SDN. BHD. (583825-U)
(formerly known as Quasar Industrial Vehicles Sdn Bhd)

www.dongfeng.my

Head Office : Lot 11, Jalan Perusahaan 2, Kawasan Perindustrian PKNS, 68100 Batu Caves, Selangor, Malaysia.
Penang Branch : Lot 1481, MK 14, Jalan Raja Uda, 12300 Butterworth, Malaysia.
Johor Bahru Branch : No. 4A, PLO 136, Jalan Angkasa Mas 2, Kawasan Perindustrian Tebrau II, 81100 Johor Bahru, Johor.

Tel: +6(03) 6187 8000 Fax: +6(03) 6187 7000
Tel: +6(04) 380 8325 Fax: +6(04) 380 8327
Tel: +6(07) 352 0890 Fax: +6(07) 352 0891



Standing the sands of time: Sin Lian

With the growth of the Iskandar region, banking on smarter fleet management Sin Lian is gearing up to meet the transportation demands for aggregates.

In 1974, having seen a need for transportation services in the Johor Bahru area, Law Ngau Chai took the plunge to start his own business. Today, his children have taken over the business while he is preparing for retirement at the age of 74. What started with one truck to deliver aggregates has grown into a fleet of some 50 vehicles. The son, Law Pui Chai, joined the firm in 1993 while his daughter, Lily Law, came on board in 2009. Pui Chai wanted to help grow the business and Lily saw a bright future in trucking.

Dynamic Business

While the goods transported may not need a lot of care, the rest of the operation is highly dynamic and requires a great deal of attention to detail. "Transporting aggregates gives you a very low profit margin. It is therefore highly important that you maintain your vehicles to avoid breakdowns as they will eat up your profits," says Law Ngau Chai. It is a volume game.

Sin Lian has seen good times and bad. Through clever management of the fleet the company has survived two major financial crises in 1986 and 1997. One of the issues the trio laments is unpredictable government policies such as the recently announced toll hike for the causeway to Singapore. This is impacting their business. Like many others, the driver shortage is another theme that they constantly debate.

Growth plans

However, Law Pui Chai is confident that the business will continue to grow. He elaborates "We are now seeing the economy picking up and the development of the Iskandar

region will require a lot of the type of service we offer. Our aim is to grow by 30% year-on-year." According to him, his father is a great mentor who will continue to offer support to their ambitious goals.

Restructured fleet

To achieve these goals, the company is now seeing a re-organisation. While the current fleet comprised of various brands, such as Volvo, Scania and Hino, future plans see the consolidation with one truck brand, most likely Volvo. Recently, a number of HOWO ready-mix concrete trucks were delivered and are now being tested in the field. Should these tests deliver the desired results, Sin Lian may add ready-mix concrete to the portfolio of goods transported. **F**



I want expert training and support for my in-house tyre management and fleet movement operations.



Proven Operational Efficiency

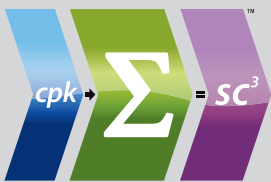

At Kit Loong Fleet Solutions, we offer a proven successful truck retail model that can add value to your business while minimising downtime. Besides supplying tyres, we also share our experience and professional know-how with your team to keep operations running smoothly. Your crew will be able to upgrade essential skills such as proper tyre application, tyre pressure monitoring, and more. In addition, you will also enjoy our KL 24/7 Tyre Rescue Service anywhere in Peninsular Malaysia. With the right training, equipment, knowledge, tools and tyre management software, we'll move your business towards achieving the benefits of SC³ and also increase your business KPI.

With the right know-how, technical expertise, innovation and 80 years' experience, you can count on us to keep you competitive, minus the downtime.

*SC³ delivers the benefits of safety, competitiveness, control and cost-effectiveness through the KL Sigma Formula, a proprietary tool that combines a sum of technical know-how, understanding of tyre movement essentials and product expertise

We are the answer.

KIT LOONG
FLEET SOLUTIONS

Retreading Process Technology

Tyre Distribution

Retailing Services

24/7 Tyre Rescue Service

Total Tyre Management

Strategic IT Solutions

Training & Consultancy

System Franchising



Cert No: SG14/04652 MY14/01336

A core infrastructure of
Kit Loong Commercial Tyre Group

Kit Loong Fleet Solutions Sdn Bhd (559903-A)
T +603 5122 2418 F +603 5121 2417

www.kitloongtyre.com

Exciting events around MIBTC 2015 lined up



Exhibitors and visitors alike can look forward to an exciting event that will have some new fringe events added to the second Malaysia International Bus, Truck and Component Expo.

With the exhibition space filled with booths from top brands showcasing their products and services, delegates can look forward to an exciting show in May 2015. “We will not stand still in our aim to innovate, to make the exhibition bigger and more exciting” says Stefan Pertz, Organiser of MIBTC. While some fringe events make a comeback, others are added.

Scania Driver Competition - MIBTC Edition

If you have a valid driving licence for trucks you may head on down to the open air car park space to test your skills in this instalment of Scania’s signature competition. Scania prime movers wait for you and once you have strapped in, you may “knock the cones”. Each day, Scania will honour the best driver in an awards ceremony on their stand. This competition is open to drivers all any brand truck.

In addition, Scania will bring back their Driver’s Lounge. This time it will be located on the Mezzanine floor overlooking the halls.

RC Truck Racing

Some delegates could not get enough of these and we are bringing them back for your entertainment and viewing. Drivers of these model trucks will battle it out on the purpose built track. While the trucks may be smaller than the prime movers use in the Scania Driver Competition, they are certainly as nimble. For those without a licence, this may be a challenge to take to see their abilities behind a truck’s steering wheel.

Best Booth Design Award

Many exhibitors put a lot of effort into the design of their booth. We will honour this with a “Best Booth Design Award”. The voting will be done by the visitors of MIBTC 2015. The winning booth design



will be honoured with a cash prize, so you may want to get your agency to spruce things up a bit!

Media Round Tables

Important issues need to be tabled for everyone in the industry to know about them. Each of the three days we will tackle an important topic and discuss them. For this we will invite media and podcasts allow everyone to learn what has transpired. Each of the three Media Round Tables is looking for a sponsor. If you would like to have your name associated with one of the topics, please get in touch with us. **F**



Event Dates
Title: Malaysia International Bus, Truck and Components Expo 2015, MIBTC 2015
Venue: MIECC, The Mines
Date: 14 - 16 May 2015



 I need a reliable 24/7
 tyre rescue service that
 responds on time anywhere
 in Peninsular Malaysia. 



Proven Operational Efficiency



This is it.

Our professional tyre rescue teams are committed to act within a fixed response time to help minimise your truck's downtime. So if we say "2 hours," we'll arrive not a moment later or else, you pay nothing on the service charges*. Operating 24/7, your tyre problems will be solved on the spot using certified service methods (ISO 9001:2008 QMS) and materials. Through the proven benefits of SC³ and established tyre rescue network anywhere in Peninsular Malaysia, we'll make sure your truck gets on the move again as soon as possible.

With the right know-how, technical expertise, innovation and 80 years' experience, you can expect assistance on time, every time.

*SC³ delivers the benefits of safety, competitiveness, control and cost-effectiveness through the KL Sigma Formula, a proprietary tool that combines a sum of technical know-how, understanding of tyre movement essentials and product expertise.

*Travel and labour charges

KIT LOONG
TYRE RESCUE SERVICE

Retreading Process Technology

Tyre Distribution

Retailing Services

24/7 Tyre Rescue Service

Total Tyre Management

Strategic IT Solutions

Training & Consultancy

System Franchising



Cert No: SG12/04002 MY12/00956

A core infrastructure of
Kit Loong Commercial Tyre Group

Kit Loong Tyre Rescue Service Sdn Bhd (600754-V)
T +603 5122 2418 F +603 5121 2417

www.kitloongtyre.com



HINO Motors officially opens new Malaysian manufacturing plant at Sendayan. Phase two of project already in progress.



After four decades in Malaysia, Hino Motors has finally opened its first production facility in Malaysia. The state-of-the-art RM172 million facility, known as Hino Motors Manufacturing (Malaysia) Sdn Bhd (HMMMY), is located on a 170,000 square – metre site in Sendayan TechValley.

With a 350 - strong workforce, it has an annual production capacity of approximately 10,000 units. It manufactures the full range of Hino products comprising light, medium and heavy duty trucks and buses for the Malaysia market. The plant, which officially rolled out the first made-in Sendayan Hino vehicle in April this year, currently produces about 600 units a month.

At the official opening ceremony of the plant, Hino Motors announced that it has already proceeded with the next phase of its plans in Sendayan. Work on a motor vehicle pool project comprising a brand new building with 12 pre-delivery inspection bays, 12 accessories fitting bays, a paint booth and a delivery yard for Hino trucks and buses on an adjacent 57,240 square-metre site is progressing smoothly.

“This Sendayan plant is the first step towards equipping Hino Motors in Malaysia with the flexibility to respond to fluctuating market demands and capability to shorten the delivery lead time to our growing list of customers in the future. One of my



YAB Dato' Seri Utama Haji Mohamad bin Haji Hasan, Menteri Besar Negeri Sembilan Darul Khusus officially opens this state-of-the-art facility in official ceremony.

priorities is to make Hino Motors Manufacturing Malaysia a respected and welcomed member of the community and play a key role in the driving the economy of Negeri Sembilan and Malaysia," said Mr Ikuo Shibano, HMMMY Managing Director.

The opening ceremony was officiated by YAB Dato' Seri Utama Haji Mohamad bin Haji Hasan with the signing of a commemorative plaque and "Kagami Wari" (lid breaking ceremony). The ceremony continued with the tour inside the factory.

The follow-on project, costing some RM12 million and scheduled for completion in November this year, would also incorporate a Customer Total Support Centre to be operated by Hino Motors Sales Malaysia with the aim to provide customers with training on eco-friendly and safety driving techniques.

HINO's main competitive edge has been its ability to offer a complete range of commercial vehicles ranging from four-wheel light commercial vehicles (LCV, HINO 300 Series), medium-heavy commercial vehicles (MCV, HINO 500 Series), prime movers (HINO 700 Series) to buses that are renowned for their quality, durability, and reliability. For each model, HINO is also able to offer different chassis variants to suit different purposes. **F**



HINO launches 3S Dealers in Nilai and Temerloh

Soon Seng Truck & Parts Sdn. Bhd. and Teck Lee Motor Agency Sdn. Bhd. join HINO's growing network of 3S dealerships in the country and is set to offer a true Japanese service experience.



Hino Motors Sales (M) Sdn Bhd (HMSM) has launched its newly upgraded Hino 3S Centre (Sales, Service, Spare Parts) in Nilai and Temerloh to serve the growing demand of HINO vehicle owners in these areas. The grand opening events at both locations were officiated by HMSM Managing Director, Mr. Nobuyuki Tanaka. The new 3S dealership aims to satisfy higher demand for quality products and services.

Soon Seng Truck & Parts

Soon Seng Truck & Parts started their partnership with HINO back in 2009 in Nilai as 1S Sales Dealer. After 5 years, SSTP has upgraded the operation from two locations of Sales & After sales to a proper state-of-the-art 3S outlet under one roof. There is a premium demand on the need in accordance to its excellence in sales and after-sales support. Managing Director of SSTP, Mr Chan Swe Wah is very optimistic of being a HINO Authorized Dealer with a simple reason that HINO has full commercial vehicle line up with a "Perfect Fit" for every customer's need.

SSTP is located at Lot 35338, Persiaran Pusat Bandar Mini, 71800 Nilai, Negeri Sembilan. It is strategically located at the hub of rapidly growing business area covering an area of approximately two acres. Moreover, the industry sections,

wholesaler, logistics, SME operators and transportation are among the strongest economic activities in the area. This newly upgraded centre comprises a spacious new office for grand showroom, administration office with a workshop for repairs and maintenance works - staffed by a team of ten skilled HINO technicians which can serve up to 30 HINO trucks or buses per day in accordance to HINO's highest standard of quality and safety. These include of 8 service bays, two express and one final inspection for MCV & HCV & Bus service, which sums up to 11 bays in total.

Teck Lee Motor Agency Sdn. Bhd.

In conjunction to its newly launched 3S Dealer, Teck Lee Motor Agency Sdn. Bhd. (TLMASB) had organized a free inspection of PROCARE activity at its premise and nearby Temerloh town on the 17th & 18th Sept 2014. The event was made to provide an opportunity for the HINO's owners to have a free inspections performed by the trained mechanics and to show HINO's commitment in providing the best after sales services to the community nearby.

TLMASB has been in the automotive industry for the past 28 years as a used car dealership. They started their partnership with Hino in 2012 in the



Temerloh 1S show room. Shortly after its second year in the business, TLMASB has moved up a notch by upgrading their operation to the 3S outlet. There is a premium demand on the needs which drives to its excellence in sales and after-sales support. The Managing Director of TLMASB – Mr Lim Swee Tin is very optimistic about being a Hino Authorized Dealer given this encouraging sales records. He is confident that TLMASB is able to maintain the status of an undisputed Hino dealership in Pahang for years to come.

Riding on these occasions, HMSM is emphasizing on the unique development of HINO's vehicle concept based the needs of businesses, drivers and transporters. It has been designed for the adherence of QDR (Quality, Durability and Reliability) concept encompassing total reliability, fuel efficiency, powerful engine performance, safety and comfort driving. Mr. N. Tanaka, said, "One of HINO's principles is to develop the products with focus on the importance to QDR (Quality, Durability and Reliability). Hence, it is widely accepted by Malaysian customers. In GVW 4 ton and above, Malaysia Commercial Vehicle market, HINO is No. 1 since 2010." 





Conti360° Fleet Services.

YOUR One Stop Solution To Lowest Overall Driving Costs



ContiFitmentService™
Creates the perfect conditions



ContiFleetCheck™
Optimizes your tire costs



ContiFleetReporting™
The analysis that summarizes everything



ContiCasingManagement™
Turns worn tires into cash



ContiBreakdownService™
Back on the road again fast



ContiBreakdownService™
Toll Free: **1800 88 1024***

24hrs/7 days Breakdown Services
Applicable to West Malaysia.

*Terms & conditions apply

Continental Tyre PJ Malaysia Sdn. Bhd. (4296-K)
(formerly known as Continental Sime Tyre PJ Sdn. Bhd.)
3rd Floor, 2 Jalan Tandang, 46050 Petaling Jaya
Selangor, Malaysia
Tel : +603 7787 8888

www.continental-truck-tyres.com/my

Continental 
The Future in Motion

Johor Sand & Granite Lorry Operator's Association carries the load

Hand in hand with its members, the association is helping to improve the industry

The Johor Sand & Granite Lorry Operator's Association had humble beginnings when it was founded in late Feb 2012 with only 7 members. Having rapidly grown its membership, recently, at the second annual dinner, over 1000 people gathered, supporting its President.



The association was formed in order to provide a business information network and share knowledge and information among the members. It also aims to promote a fair business atmosphere and opportunities to the industry and to improve relationships among operators in the region. Lastly, it is helping to avoid price wars among its members.

Important tasks

A key task is to work together with government agencies to improve the national road traffic. This is done by means of providing information to national road safety committees and in cooperation with government authorities like JPJ, Traffic Police and PUSPAKOM to name just a few.

In line with this, the association is planning to develop a training centre to conduct classes for the members' drivers. The idea is to provide training courses pertaining to road safety, enhance basic knowledge of lorries (mainly rigid / tipper) and their maintenance. "We believe that the drivers are one of our assets and it is important to upgrade their skills for better performance and better return to the company owners" says Chia Jee Onn, President of the Association.

Milestones

The association was successfully registered with ROS 16th April 2012 and it immediately took to handling important issues. Said Chia Jee Onn "We met up with the Minister of MOT YB Dato' Seri Kong Cho Ha on 3rd May 2012. The Minister sent the Pengarah Dato' Hj Solah & Pengarah KA Ir. Mohamad Dalib to meet us in Johor Bahru and we had a dialogue at JPJ Taman Daya on 14th May 2012. At this key event, together with Pengarah JPJ-Johor, Pengarah PTG Johor, PTD Kulajaya, SPAD, JKR, PUSPAKOM and some 50 people from among our members joined the meeting. There was a lot of interest in the outcome of our discussions and we even had people waiting for the result of session outside the meeting room."

The association managed to draft the specification or standard conditional of the lorry tipper that is suitable to ferry sand and granite. In view of the new organizational structure of government agencies dealing with this kind of issues, this specification or standard is currently conditional and is slated to be announced by SPAD.



On 28th June 2012, we met with Singapore's Land Transportation Authority (LTA) in a closed-door dialogue to discuss on the overloading and road safety issues, such as:

- Unscrupulous use of tipping semi-trailer (Giant Bucket) lorries to ferry aggregate materials from Johor to Singapore via the causeway.
- Ferrying granite products avoiding the weighting process.

On 24th Sept 2013, a seminar was jointly organized with PUSPAKOM Johor Bahru, catering specifically to member's workshop foremen to aim for better understanding of the standard

of inspection by PUSPAKOM. Special attention was given to the critical parts of breaking systems and the balancing. Some 34 foremen attended the half-day seminar at the PUSPAKOM Taman Daya Branch.

It was only on 30th Sept 2012 that the official opening of the association took place in its own premises at Taman Johor Jaya. It was held in conjunction with a truck show during the event and 460 people attended the event.



Charity work

The 2nd Anniversary Charity Dinner with HOKA Truck Exhibition was held in Restaurant Pekin Sutera Utama on 22nd June 2014 with an attendance of approx. 1,100 people. The participants were business owners in the trucking, construction and logistic companies. The event was officiated by the Guest of Honour En. Abdul Halim bin Husain (SPAD Head of Operation). A total of RM 10 000 was donated to JUITA Johor (Orphanage Home) and RM 10 000 was received by Johor Tiong Hua Association Temple Charity Foundation, Southern College. 





Shock Absorber for Commercial Vehicles 商用车辆减震器

Original Equipment (OE) Products

GENUINE ITALIAN BRAND

Distributed By:

 **YONMING[®] GROUP** (716296-P)

WWW.YONMING.COM

KL (HQ) Tel : 603 - 6251 944g

E-Mail : yhmh@yonming.com

Zukunft bewegen



IAA

25. SEPTEMBER –
02. OKTOBER 2014
HANNOVER

Driving the Future at IAA Hannover

Asian Trucker re-visits the Internationale Autoausstellung in Hannover to report about the latest developments and trends in our industry.

For our Cover Story "IAA Special" we visited the world's largest commercial vehicle exhibition. Held under the headline "Driving the Future" saw new records being set, innovations introduced and our team busy meeting with readers and business partners from South East Asia. This year the IAA Commercial Vehicles, which was first held as a separate trade show in 1992, was taking place for the eleventh time in Hannover and has developed into the world's leading international trade fair for mobility, transport and logistics.

Knowing about your interest in the IAA 2014 we have visited this expo. IAA Commercial Vehicles has proven to be a stable pillar of this key industry with around 2,000 exhibitors from 45 countries, and showcased numerous innovations and technological highlights in the commercial vehicle industry.

The atmosphere was ecstatic as the industry has regained its confidence and with growth potential in Asia, many are looking East for sustainable expansions.

The VDA

Every year, the German Association of the Automotive Industry (VDA) stages the "Internationale Automobil-Ausstellung (IAA)", or International Motor Show. In odd-numbered years the IAA

focuses on passenger cars (next IAA Cars: 17 – 27 September 2015 in Frankfurt/Main), and in even-numbered years it covers commercial vehicles.

The VDA consists of more than 600 member companies with a total workforce of more than 765,000. Its members are companies that are industrial manufacturers of vehicles and their engines, trailers, vehicle bodies and buses, vehicle components and accessories within Germany. The VDA's head office is located in Berlin. It also maintains an office in Brussels. The VDA promotes the interests of the entire German automobile industry in all aspects relating to motor traffic, such as industrial, transport and environmental policy, logistics, technical legislation, standardisation and quality assurance, both nationally and internationally. It works actively to ensure that individual mobility remains affordable to everyone.

The VDA is now 113 years old. It was established in Eisenach in 1901 by eight companies under the name "Verein Deutscher Motorfahrzeug-Industrieller (VDMI)", the Association of German Motor Vehicle Industrialists. Its initial tasks included the promotion of road traffic, the prevention of "burdensome official actions" (taxation), tariff protection and the supervision of automobile exhibitions. In 1923 it was renamed the "Reichsverband der Automobilindustrie (RDA)", the "Reich Association for the Automobile Industry". In 1946 it adopted the name "Verband der Automobilindustrie" (German Association of the Automotive Industry).



SCANIA



MAN



LAMILUX



HYVA



DOLL



WABCO



Brianza Plastica

Milestones of IAA

1897 First IAA held at the Hotel Bristol in Berlin. Eight cars are presented to the public.

1989 The last IAA to feature both cars and commercial vehicles confirmed that the exhibition site in Frankfurt was now too small for this major event. Almost 2,000 exhibitors squeezed onto an exhibition site measuring 252,000 square metres.

More than 1.2 million visitors attended the event. Because of the high demand, it was no longer possible to meet exhibitors' requirements for adequate exhibition stands. In view of this, the VDA decided to hold two IAAs from now on.

1992 The first IAA Commercial Vehicles saw 1,284 exhibitors from 29 countries. The exhibition site measured 252,000 square metres. Some 287,000 people visited this IAA, 66 per cent of them were trade visitors. This confirmed that the VDA's decision to split the event was right.

2012 The IAA show has never been more international: IAA hosted exhibitors from 46 countries. With 1,904 exhibitors and 262,300 visitors, the trade fair presenting the slogan

“Commercial vehicles – Driving the Future” dramatically exceeded expectations. The exhibitors took advantage of this showcase to introduce their contributions to the most important trends, such as Euro VI, aerodynamics, alternative drive systems, intelligent and predictive gear shifting, safety, lightweight construction, networking/telematics and extra-long trucks.

With in total 354 world premieres – more than two thirds of suppliers introduced world premieres – the IAA 2012 was setting a new record for novel products. 2,087 journalists from 56 countries reported on the latest models and innovations. Test drives in electrical vehicles were offered on the trade show grounds for the first time.

This year, Asian Trucker again spent time at this most important exhibition to find out what industry leaders have in store for the future. On the following pages you will read about trucks, components, thoughts and trends. All of which we have gathered in exclusive interviews in an effort to bring you the latest, the freshest and most relevant content. Many of these companies will be participating in MIBTC 2015 and we hope to see these innovations at our show in Malaysia too. **F**

Brianza Plastica does it both: Continuous and discontinuous laminates

As the only manufacturer offering both methods of producing laminates in fibreglass, the company is showing innovations at IAA.

The Brianza Plastica S.p.A. group consists of four companies contributing to the study, realisation and supply of very high quality materials and products, making the group one of the most qualified in the industrial and civil overlay and insulation sector. As we meet Andrea Bollani at IAA, Area Manager, he also highlights that insulation is one of the applications that Brianza Plastica is strong in and seeks to grow further.

The main difference between continuous and discontinuous laminates is that the first is produced using machines fully automatized, while the latter is a manually made. Brianza Plastica's continuous version is called ELYPLAN and ELYCOLD is the brand of the discontinuous one, both have a high quality surface and we might underline this specific peculiarities:

ELYPLAN is a laminate made with a continuous production line using hot polymerisation. Continuous production offers real economic benefits over discontinuous technology, with excellent aesthetic qualities that, in the High Finishing version, rival the finest laminates made with discontinuous methods. Elyplan is therefore the best solution when the key factors are mechanical strength, dimensional tolerances, and value for money. Elyplan laminates come in rolls and sheets up to 3200 millimetres wide. There is no theoretical limit on the length, which is agreed to suit the customer's requirements.

ELYCOLD laminates, conversely, are made on a discontinuous production line with cold polymerisation that avoids thermal shocks and ensures a top-quality product with a perfect flat finish. Elycold fibreglass sheets emerge with a superlative aesthetic effect that is ideal where a smooth, shiny, totally flat surface is required. Elycold laminates, finished with gelcoat, are made in rolls and sheets up to 3400 millimetres wide and 60 metres long.

While both production methods use the exact same raw materials, to produce the manually fabricated ELYCOLD

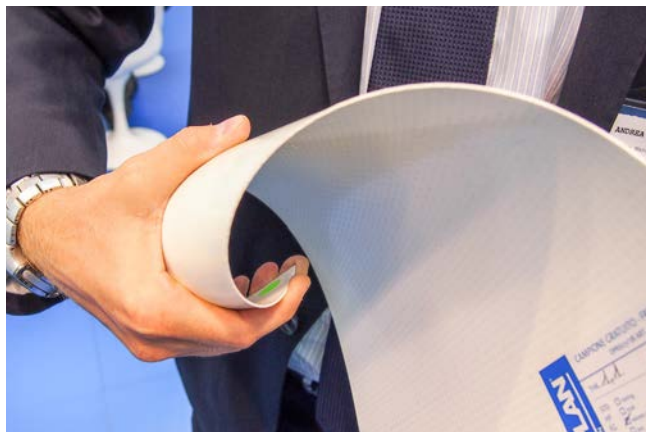

highly skilled and trained operators are needed. While other manufacturers focus on either one of these methods, Brianza Plastica is the only maker in the market that offers both. This allows body builders and customers to source their materials for varying needs from one source. The respective area manager will be on hand to assist customers to identify the right application.

At the IAA 2014, Brianza Plastica is showing ELYPLAN EXTRA GLASS; developed according to market's needs, it is now a standard product.

This variant is extremely tough, but also flexible and light. It is available with or without gelcoat. It contains a high percentage of glass which provides the extreme rigidity and lightness at the same time. ELYPLAN EXTRA GLASS would be suitable for applications such as the roof tops of buses. It is also highly recommended for inner and outer walls of temperature controlled vehicles. The second innovation shown is the ELYPLAN HIGH FINISH. This laminate uses "chopped strand mat" which gives the laminate a better appearance by reducing the visibility of the fibres on the surface. "This variant is highly suitable for large commercial vehicles where the economic advantages come from the production method" said Bollani.

One of the obstacles identified by Bollani is the fact that many body builders are not familiar with composites and are therefore hesitant to use them. However, when Brianza Plastica's representatives explain the benefits, things change. Laminates are waterproof, don't need painting as they can be produced in all sorts of colours, are easy to maintain and repair and are durable. As such, the life of laminates is much longer than that of metal panels.

The company has seen a strong growth potential in Asia. Said Bollani "I am constantly travelling the area. Asia is the growth market for us as this is where new economies are now in a state where sophisticated solutions are needed to drive growth further. If anyone is interested in a presentation, they can contact me via a.bollani@brianzaplastica.it and I will come to meet them." In line with the company's initial direction of "insulation", the cold chain providers in Asia are the prime market. "Meanwhile, Brianza Plastica will not forget the European home market" Bollani closes. **F**



Scania sets records and heads into new directions with renewable energies



The Swedish truck and bus maker sees increased profitability for clients with renewable energy solutions to propel trucks and is asking the entire industry to join forces to combat CO2 emissions

We meet Henrik Henriksson, Member of Executive Board, Executive Vice President, Head of Sales and Marketing on the day before the official opening of the IAA and the Scania stand is already abuzz with people wanting to know about the latest innovations from the Swedish brand. "We all need to come together to address the CO2 challenge. Not only as one truck maker at a time, but as an entire industry" Henriksson is urging fellow truck makers. "We are extremely proud to have won the Green Truck of the Year Award. And not only by a small margin, but by a remarkable 1.1 litres (per 100 Km) less fuel consumed compared to others" he is proudly announcing. This is already the third generation G410 Euro 6 trucks and Scania has learned a lot and values this great achievement. The long haulage trucks Scania runs in its Transport Laboratory are down to 23.3 litres per 100 on their 6,000 km routes transporting components between its own factories Sweden and the Netherlands.

Scania has decided to focus on renewable energies as future fuels. According to

Henriksson, this is the way forward as biofuels are CO2 neutral and in addition help reduce waste that cannot be used otherwise. Taxation and infrastructure are issues that need to be addressed though. For example, it may not be required to subsidise biofuels, but at least the taxes should be the same as for Diesel at the moment. Instead of waiting and hoping for a perfect solution, Scania is urging the industry to work with what is available and to act now.

The notion of improving fuel efficiency is in line with Scania's approach of improving their customers bottom line. In working with customers and customer's customers, the company is able to further improve their offering. Said Henriksson "It is crucial to understand our customer's businesses. That way we can help them to get better". He has seen this in practice as he recalls his most memorable moment of his career when he saw a Scania V8 in an Indonesian mine pulling some four trailers with over 200 tons payload.

In asking the right questions, Scania is able to find the solutions the customers

require. With the various engine variants, which now also include gas, the company has the widest range of combinations of chassis, cab and engine. This allows for highly customised applications to fit every customer's need. Through this, Scania is able to go into very fine details and to optimise the vehicles to perfectly fit the customers' needs.

Henriksson highlights the Asian market: "We have been there for a very long time. Scania has invested heavily and created growth. We have also seen fantastic developments of business and people. This is where we will nurture future leaders. In others words, we will not leave!" **T**



DOLL sets a new standard for flexibility in heavy loads

When it is no longer enough to just have one application for one purpose, the new DOLL 6-axle panther low-loader offers a never seen before flexibility in trailers.



The DOLL panther is already a feast of tech know-how. However, for this version, the Oppenau based company has yet again exceeded expectations and added features that possibly make this trailer the most versatile in its class. Said Mr. Grunwald "Our client wanted to have a purpose built trailer that can handle a wide variety of loads. They needed a trailer that can be a low-loader and a semi low-loader." Therefore the trailer has a bed that can be connected in two positions to the platforms. As with the original panther, there is also a telescopic extension. Here again DOLL has found a superb solution to the request to allow for varying weight distribution: the bed with the telescopic extension can be swivelled around so that the extension is on either end of the platform.

The telescopic extension comes into play when the client is moving special goods that are light, but 5 meters wide and some 20 meters long. It is clear that the approach taken by DOLL makes this particular panther variant a true all-rounder as it can move heavy loads, such as dumper trucks that would



sit on the low bed, as well as oversized loads with less weight. It would even be possible to replace the current bed with a shorter version to move even heavier loads. Moving the bed is a simple task, thanks to thought through engineering. Mating the bed and platform is done via a giant bolt that even has a back-up mechanism to loosen the bolt and the cables can run above or below the bed. At 80 Km/h, the permissible payload is approximately 69 500 Kg for the configuration shown at IAA. All trailers shown by DOLL at the IAA are already sold and clients are happy to see their own trailers on display.

The gooseneck is adjustable in four different positions to adapt to the different loads and to comply with laws and regulations. We chatted with Markus Renner, who headed the development of this trailer. "The development took some six weeks full time. The result is truly exceptional. Thanks to a client that wanted to push the envelope we have an amazing trailer here to show" he said. Added to the trailer is also a sophisticated CAN-bus system that allows to adjust the settings of the entire trailer either from the gooseneck or the back of the trailer. That way, long ways back and forth are avoided. "It is amazing how you can set up the entire system from one point without moving around" Renner said. The CAN-bus also manages the automated lubrication system. Renner explains "Why would you want the lubrication running on full when the engine of the truck is running, but the vehicle isn't moving?" DOLL's system is managing the lubrication whereby the lubrication starts when the trailer moves at a speed of 15 Km/h. This way, there will be less excessive lubricants that may pollute the environment.

The central box frame allows for dumper trucks or excavators to drive straight onto the trailer. In order to achieve the low loading height there is no beam between the already legendary DOLL axles and suspension systems. 

LAMILUX does it again: pushing the boundaries in laminates



We meet with a clearly proud crew at the LAMILUX stand where the company shows innovations that push the envelope further and show what the future in composites may look like.

Prominently displayed is the TÜV symbol at the LAMILUX booth. After winning the 2012 European Frost & Sullivan Award for New Product Innovation, the company has continued to work with TÜEV, the testing and certification body, to demonstrate the superiority of their products. Present at the booth was Mr. Jochen Specht, General Sales Manager, innovative fibreglass solutions, and he explains this: "We want to offer our clients a product that they can use, that can be trusted. Every meter, every time and in every application." According to Specht, this is the kind of customer service that LAMILUX prides itself in. By carrying out these tests, the customer doesn't have to conduct them and will know that the solutions from LAMILUX will meet the requirements of the job at hand. Said Specht "Our USP is the consistent and reproducible quality as well as our approach to be an innovator."

Currently, the markets are India, South East Asia and China which have a very high potential. Japan is also on the list of markets that is of interest and they are looking for distribution partners there. LAMILUX however does not just provide the product, but also service and development support that works hand in hand with the local clientele. Meanwhile, LAMILUX is also expanding its product offer from trucks to buses and has seen some major successes. As Specht explains, composite materials are common in trailers in Europe and the move to offer smart solutions for buses is a natural one. Side wall and roof applications and the floors of luggage compartments are the main applications.

There are many benefits of using composite materials. One of the issues bodybuilders in South East Asia have to deal with is the high humidity. Composites do not corrode, thus eradicating this problem. Composites are also lighter than metals, resulting in fuel savings, while they are easier to repair. In many cases, impacts from smaller accidents can't even be seen when using composites. LAMILUX is now further innovating by using different resins and mixtures of glass / resin (increasing glass content from 25 % to 50 %). "We are now offering solutions that range from decorative to construction. The new materials are extremely durable and can withstand a lot" Specht further elaborates.

Also on display are rolls of Carbon. "This is our latest product and we are seeing a lot of interest" said Specht. The carbon runs off the production line in 3.20 meters width, making LAMILUX the only provider that is capable of producing it in this width. With Carbon, maximum weight reductions can be achieved. In Sweden, one client has already used it for a silo / tanker as well as in Germany in the sports industry.

In view of the South East Asian market, LAMILUX highlights the characteristics of their products again when it comes to cold chain solutions. Here LAMILUX is able to cover the entire chain, from warehouse to transportation in trucks to POS displays in the shops where we pick our chilled or frozen goods.

The company produces some 12,5 Million square meters of composites per year, out of which some 30 % are being used in commercial vehicles. LAMILUX expects both of these numbers to increase. **F**



WABCO is the definition of efficient technologies

WABCO's differentiation in vehicle efficiency is also rooted in a global connectivity to deliver competitive, value-based solutions in mature and emerging markets alike.



WABCO Holdings Inc. (NYSE:WBC), is a leading global supplier of technologies to improve the safety and efficiency of commercial vehicles. During the IAA the company announced the company's continued technology leadership in vehicle safety and efficiency through its advanced systems, products and services, including new fleet management solutions.

Fuel Saving

WABCO demonstrated that the company continues to pioneer vehicle efficiency technologies that address diverse customer needs globally, including fleet management solutions. For example, a truck equipped with all of WABCO's efficiency technologies can improve fuel economy by more than 10 percent, while the green solutions also reduce vehicle weight and optimize energy recovery. All this is resulting in lower operating cost and fewer emissions over the lifetime of the vehicle.

"At IAA 2014, we will once again show how WABCO's technology leadership is grounded in our unmatched ability to anticipate the efficiency and environmental needs for

tomorrow's trucks, buses and trailers in different regions of the world." said Jacques Esculier, WABCO Chairman and Chief Executive Officer.

Advanced Safety and Driver Effectiveness

Connected with customers and their technology roadmaps, WABCO's engineering and manufacturing teams develop new products and functionalities that provide:

- Greater ability to control vehicles in all difficult driving situations
- Improved driver effectiveness and comfort
- Advanced safety systems that contribute to vehicles' compliance with increasingly stringent safety and performance regulations

When it comes to Vehicle Efficiency and Environmental Sustainability, WABCO is at the forefront of the commercial vehicle industry's drive to protect the environment. The company's vision of significant improvements in vehicle efficiency and environmental sustainability is based on WABCO's focus in three key areas:

- Increase fuel savings by reducing power consumption of braking system and related products
- Improve weight performance ratios of our products by using lighter materials and enhancing the performance of existing products
- Develop energy recovery systems that recuperate energy instead of wasting it

The company's aftermarket service network covers over 110 countries and includes more than 2,200 WABCO Service Partners.

WABCO acquired Transics International in February 2014, a market leader in Europe for Fleet Management Solutions (FMS). Transics serves 1,300 customers in 23 countries with more than 85,000 connected vehicles. **T**



HYVA pumps out Innovations



If you want to lift up the profitability of your business, there is only address you should go to in order to get lightweight cylinders, clever hook loaders and skiploaders.

A lot has happened inside HYVA in the past two years. South East Asia remains a strong focus for the company, which manifests itself in the opening of HYVA Indonesia in Jakarta. To provide better support and have more control over the brand, HYVA decided to take over the former distributor and manage the affairs directly. Clients will benefit largely as HYVA can now combine the experience in mining from Indonesia with the excellent expertise in palm oil from Malaysia.

At the exhibition, HYVA staff is ecstatic as the newly Alpha range represents a massive push in terms of product innovation and opportunities to service customers better. After deep-diving into the businesses of customers, users, distributors and other partners in touch with HYVA, the result was clear: differentiated products according to market segments are needed. While in mining fast tipping is crucial to ensure quick turnarounds, road transportation needs light-weight cylinders. HYVA's new Alpha range addresses these needs and offers each segment a thought-through and clever solution. In addition, four more cylinder diameters were added to the product portfolio to allow further flexibility and adaptability.

Tipping solutions have been customised to each market segment:

- **Construction** This solution, with standard operating pressures up to 250 bar, is designed to achieve the best possible combination of reduced weight, increased tipping speed and stability.
- **Transportation** This solution is designed to maximize payload. Weight saving is achieved through light-weight brackets and new cylinders with lighter internal components. And by reducing the weight of cover tubes on FC cylinders, savings of up to 40kg can be achieved. ALPHA tractor kits are ideally suited to the latest Euro 6 truck chassis.
- **Mining** This solution is designed to perform at highest speed and to maximise performance in heavy duty conditions. The solution comprises a high quality filter, heavy duty knock-off, brackets for heavy duty conditions and the heavy duty ALPHA Series cylinder which has larger overlaps and stop and lift faces which have been redesigned to permit exceptionally high tipping and lowering increases up to 50%. For extra safety, the tipping valve is now mounted directly onto the base of the tipping cylinder.

Also on display was the Hyva range of telescopic underbody solutions which comprises light, medium and heavy series with 1-38 ton tipping capacity and strokes up to 4 metres to meet all underbody tipping demands. There is a wetkit available to suit each tipping requirement. Hyva's underbody solutions are ideal for applications requiring side tipping, for tipper crane combinations and for agricultural solutions.

Already in 2012, HYVA was offering products that no longer required welding in order to reduce building times for body builders. At this year's IAA, boltable hookloaders are on display and according to HYVA a big hit among customers. The good news is that these will be available in Malaysia next year according to Arthur van Welzen, Managing Director of HYVA Malaysia.

Besides innovative products, HYVA also pushes on with the use of interactive platforms and the HYVA academy. The latter is aiming to distribute knowledge in a fast and effective way, thus offering customers and sales staff at the same time a way to be on top of all things cylindrical. "We see more younger people taking over their parents' business. These young people are more internet and tech savvy and demand such tools, which we happily provide" van Welzen further stated. The mega trend HYVA has identified is that service is getting more and more important. According to van Welzen, it is not unusual to send Auto-CAD drawings so that body builders can integrate the products easier into their design. **T**



MAN celebrates clients during Asia Night at IAA

The event gathered Asian customers to celebrate them and with them with a delightful dinner before heading South to visit MAN factories in Germany.



Literally hundreds of MAN customers joined the Asia Night by MAN Truck and Bus as part of their IAA experience. The Asia Night is the traditional MAN event with the intention to get together with the customers from all over Asia in Germany. And that is the main reason for the name of the event given. Among other groups, MAN flew in 18 of their loyal customers from Malaysia to attending the overwhelming event.

The event also gives a chance for their customers to view the dimension of MAN in Europe. MAN only assembles in Malaysia whereas in Germany the trucks and buses are made from scratch. Customers were also taken to the engine factory and the big factory of MAN in Munich to see the manufacturing process.

“Our current focus towards the Asian region is that we want to expand our network more by selling more trucks and buses.



There is quite a strong potential we see in the Asian market for us to develop our business,” said Hartmut Mueller, Managing Director, MAN Truck & Bus (M). According to him, the IAA is a great opportunity to combine a few activities for customers as they not only see the latest products first hand, but also visit other MAN facilities in order to gain insights into the culture of the German brand.

“We are as well planning to extend our products in China and we are quite successful in Korea too. More workshops will be set up very soon. Apart from all that, our development team is currently doing research to broaden our reach in the Asian region in terms of spare parts availability in these markets,” he added.

Attending the evening was Mr Abdul Gaffar Muhammad (MARALiner Sdn Bhd) who said “I would like to give a big thank you to MAN Truck and Bus for making it possible for us to be in Germany and have such a great experience here. The Asia Night event for me was a vast chance for the business partner to assemble and build more, network,”

“This event is giving a very positive impact towards the new user of MAN products in term of to get more exposure about MAN Trucks and Buses. In additional, we can strengthen the relationship between both parties,” said Mr Shahrizal Mohd Zain, (Nozomi Express Sdn Bhd).

“There is good food and it is such a chilled environment allowing us to have a chit chat with everyone. We have been their customers for seven years and still counting. We are glad that, as a customer, we feel appreciated and this is how a good relationship is being created,” said Mr Chang (CLFL). **✚**



One-stop-shopping!



Spare parts for Trucks, Trailers and Buses



DT® Spare Parts – Genuine Quality. Durable Trust.

www.dt-spareparts.com

DT® Spare Parts offers a complete product range for trucks, trailers and buses with all required spare parts in guaranteed quality. Ask your local dealer for DT® Spare Parts products and catalogues.

The latest news about DT® Spare Parts brand products is available in the regularly "Parts info" newsletters.

Authorized distribution partners:

Sykt Selayang Muhibbah S/B
Phone +60-3 61880066
info@ssmeurolink.com

Terus Jaya Auto (M) Sdn Bhd
Phone +60-3 62588055
impexp@terusjaya.com
Kai Yuan Auto Parts Sdn Bhd
Phone +60-3 62575019

Twinco Far East Sdn Bhd
(A member of Solid Automotive Berhad)
Phone +60-7 2325888
keddy.ker@twinco.com.my
www.twinco.com.my

Subscribe to the Newsletter
<http://newsletter.dt-spareparts.com>



Belton Axle Components Sdn Bhd



Getting the wheels under your truck and trailer, Belton Axles manufactures and trades automotive components for passenger cars, undercarriage components for 4-wheel drives, light and heavy commercial vehicles.

All the way to Sungai Siput, Perak, Asian Trucker went for a factory visit of the manufacturing of automotive brake drums and hubs. Belton Axle Components Sdn Bhd (BAC) is a joint venture between Mohd Nizam Bin Mohd Hassan, Mohd Fadzil Bin Mohd Hassan, Farha Aziz Fawzy and First Growth Steel Holdings Sdn Bhd. The company is principally involved in the manufacture and sale of automotive axle components, brake drums, axle hubs and the assembly of the two.

The manufacturing runs on three production lines, with machinery and equipment worth at current market value of a several million Ringgit Malaysia. Two lines are designated for the manufacturing of big brake drums, whilst the third line is designed for the manufacture of small brake drums. Castings are purchased principally from Zibo Benito Metal Work Co Ltd of China and Bakrie Tosanjaya of Indonesia.

Products manufactured by the company are distributed to more than 48 countries worldwide and include direct and indirect supplies to reputable Original Equipment Manufacturer (OEM) customers from overseas. In the local Malaysian market, the

company supplies the brake drums and hubs to major OEM customer, Isuzu Hicom Malaysia Sdn Bhd – IHM (formerly known as Malaysia Truck and Bus Sdn Bhd).

“The challenge that we face in our company is that we are not a multinational company, therefore we find it difficult to find a stable position in the market. I am glad to say that customers that have been with us since the first day, remain to have the faith in our product up until now,” said Mohd Nizam, Executive Director of Belton Axle Components Sdn Bhd.

“Our products are superior in terms of quality compared to certain imports. For B-Axles the technology has advanced and we boast complete machining facilities which include a honing process. This improves the brake drum lining surface to a very high level of finishing that others do not have,” he added.

We found that it has been an educational tour to the factory and obtaining a clear explanation of the brake drum making process. The factory is filled up with integrated machines from Japan to maintain the premium standard of the product.



Quality Assurance

The manufacture of reliable and durable Brake Drums that are safe for use is BAC's utmost concern and BAC's management believes that the most appropriate testing equipment is required in governing the consistency of the product quality. Its well equipped QA laboratory is fitted with advance testing equipment such as Computerized Coordinate Measuring Machine (CMM) to ensure precise profile for best performance. The excellent service has led to the Quality Certification ISO 9001:2008 by Standards and Industrial Research Institute of Malaysia (SIRIM) since year 2001.

Belton Axle Components Sdn Bhd is planning to increase exports and are working closely with local automotive franchise holders to initially export our products to their counterparts in the ASEAN region and subsequently globally. 

With the new Ford Transit everyone goes further



Ford announces the availability of locally-assembled Transit and launches nationwide commercial vehicle centre network.

During this two-in-one occasion held on 22nd July 2014 the locally-assembled Transit full-sized van and a network of nine Commercial Vehicle (CV) centres offering specialist sales and after sales services as part of a strategic growth plan for Malaysia were launched.

Success and Legacy

The Ford Transit is one of the most common large vans on Europe's and America's roads, with it being well liked by users and fleet operators alike. The Transit was first introduced in Germany in 1953, but it didn't arrive in the UK until 1965. It was an immediate success, with it being praised for its flexibility, comfort and ease of use. As a result of its popularity, Ford dubbed it 'the backbone of Britain'. Over five million Transits have been built to date, and the range shows no signs of stopping and Transit has been the best-selling light commercial vehicle in Europe for 40 years.

Malaysian competence

Sime Darby Motors is one of the major automotive industry and luxury marquee players in Malaysia, Singapore, China, Australia and New Zealand, with business activities that vary from country to country. These include importation, assembly, distribution and retail of vehicles. This division represents various brand and luxury marquee ranging from BMW, Mini, Rolls Royce, Porsche, Jaguar, and Lamborghini, to Hyundai, Land Rover, Ford, Peugeot, Mitsubishi, and SsangYong. Besides the Ford Transit, the Ranger is one of the vehicles that is being put to the task for businesses.

For the Malaysian market, Ford is launching two types of the iconic Ford Transit which are the window van and the panel van. Based on these two base models, special purpose vehicles like ambulances, food trucks or even mobile offices can be custom-build.

Window van (high roof)

Its car-like interior complements a clever seating configuration that can comfortably accommodate up to 13 people (including driver). The Malaysia market pricing for the panel van would be RM 139,888 (Company Commercial Registration)*. The features include two-tier wing mirror, sliding doors and large lenses headlight, grab handle and illuminated step, spacious cabin for comfort ride, generous space for easy access, cabin comfort and a long list of safety features.

*Please refer to Sime Darby Motors for exact pricing

Panel van (medium roof)

With a high roof, long body and rear wheel drive, it has the capacity and appetite for hard work. You will find full-height rear doors, dual sliding side load doors and a load platform with minimal wheel arch intrusion to help get the job quickly, safety and efficiently. It consists of flat body panel, 180 degree rear door, 4-point rear parking sensors, innovative step bumper, front windscreen defogger, generous rear loading, wide load area, over-cab storage and load compartment tie-downs.



Safety and security

The Ford Transit is consistently recognised as one of the leaders for security in its class. Transit offers a complete portfolio of proven safety and security features:

- **Electronic Stability Programme (available in window van)**
- **Brake Traction Control System**
- **Brake Assist (available in window van)**
- **Hill Launch Assist (HLA)**
- **Dual Front Airbags**
- **Passive Anti Theft System (PATS)**
- **Remote key function**

"Millions of customers around the world have embraced the Transit because of its high quality, unrivalled toughness and value-for-money, and we're so proud to bring this iconic Ford vehicle to the Malaysian market," said David Westerman, Managing Director, Malaysia and Asia Pacific Emerging Markets, Ford Motor Company.

Both Transit variants are powered by a Duratorq Turbo Diesel Common Rail Direct injection. The TDCi engine uses a variable geometry turbo-charged capability to improve performance and optimise fuel efficiency. Delivering impressive performance of

155 PS of power and peak torque of 385 Nm, the powertrain also offers exceptional fuel consumption from as low as 8.91/100 Km.

Specialist Centre for dedicated sales and services

As well as being the exclusive sales point for the locally-assemble Transit full-sized vans in Malaysia, Sime Darby Motors will also extend after sales support to all Ford fleet customers. Offering while – you- wait servicing and extended hours, these will also have flexibility to provide priority treatment for all urgent work, minimising downtime by ensuring sufficient capacity and specialisation for commercial and government fleets. In the event of a breakdown, customers have access to the Auto Connexion Road Assist towing service which operates 24hours a day, seven days a week.

"As we move forward with class-leading products from Ford, we are committed to re-doubling our focus on providing the best possible customers service. These Ford CV Centres are a clear demonstration of our combined commitment and determination to offer a higher-level of overall ownership experience," said Lee Eu San, Managing Director of Sime Darby Auto Connexion. **F**



Save your truck from fire with Aces Synergy Engineering's fire suppression equipment



"Such events might be unavoidable if they are meant to occur, but there is still a chance to save some important components in the truck, for example the engine says Badrul Hisham Md Noh, Director of Aces Synergy Sdn Bhd. The company is trading in and providing engineering services such as general civil, structural works, mechanical, electrical and facilities management. Their "Fire Suppress" range is an emerging player in the global micro-environmental fire protection and fire suppression industries and may be a valuable addition to any commercial vehicle.

Fire Suppress Detection Tubing System

This product that can protect for example the engine compartments of commercial vehicles. It can also be used in other sections of the vehicle depending on where you want it to be placed. Detection tubing reacts to heat to trigger the system. The beauty of this device is that it does not require any power to work. It

The tragedy of a truck catching on fire is one of the most unwanted things to happen to any truck owner as it may result fatal injuries, damage to property and will suffer significant losses.

can be used as both a detection device or as an agent delivery system. When installed the tubing is under pressure. In the presence of fire, it will burst at the point closest to the fire. In doing so, it will release the fire extinguishing agent directly at the source of fire. Eco7 are one of the effective fire extinguishing agents used in these applications.

Eco7

Fire Extinguishing Liquid Clean Agent called Eco7 (GB17835-2008) has high performance capability in extinguishing fires in most applications including vehicle tyres, rubbers, plastics, and many more. It contains a natural ingredient that will not cause any destructions or hazards to environments and humans. Eco7 is offered by Fire Suppress in a 400mL container.

There are two choices for the system. You can choose the Fire Suppress Direct Action Release System (DAR) or the Fire Suppress Secondary Action Release System (SAR). The DAR system works



Mr Badrul Hisham Md Noh, the Director of Aces Synergy Sdn Bhd.

In 2007 he set up Aces Synergy Engineering Sdn Bhd where he is the CEO and shareholder. Aces Synergy is focusing in M&E in land, marine, Oil & gas sectors. ACES, currently is pursuing a local status fire suppression system featuring HFC227ea clean agent.

Currently, he is actively pursuing marine sectors as it is a lucrative market and fewer competitors. So far, he has proposed high pressure and low pressure water mist fire fighting system for future Navy's new generation multirole support, frigates and patrol vessels. Negotiation with other marine sectors and oil & gas are also underway.

as a fire detection, a nozzle and a fire suppressant delivery system, meanwhile the SAR system work as detection device only.

Asian Trucker's view,

We won't say that installing such system will completely fire-proof your truck. If your vehicle catches fire, it won't be able to save your truck 100% but it is better to be prepared for a rainy day as it can prevent a total loss and help reduce your cost. The Fire Suppress will act quickly to protect certain compartments. If the fire starts at the place where you have installed the product, it may cause almost no damage. Given the environment trucks operate in, the fire spreading onto other vehicles or property may be prevented through the use of systems like this. If anything, the idea of protecting human lives is one we certainly won't suppress. **T**



JOSAM Wheel Alignment

For ALL Commercial Vehicles



Twin Steer alignment is Easy !

Only All Wheels & Axles Alignment can give you :-

- ◆ 15 - 50% decreased tyre wear
- ◆ 2 - 10% lowered fuel consumption
- ◆ Happy driver

Call us for Free Consultation & Demonstration !

Manbeni Machine Tools (M) Sdn Bhd (268550H)

No. 21, Jalan 5/118C, Desa Tun Razak, 56000 Kuala Lumpur, Malaysia

Tel : 603-9171 6323, 9174 2520

Email : manbeni@gmail.com

Fax : 603 - 9173 9323

Website : www.manbeni.net



Trucks with maximum protection from Rheinmetall MAN Military Vehicles



SX 45 8x8 Recovery off-road

Last month, I was part of the Asian Trucker team that was heading to Port Dickson for an event with Shell. Along the way there were five tanks coming up the highway on the opposite way. These tanks looked pretty cool I must say. This incident, has led me to do some research about military trucks and I found Rheinmetall MAN Military Vehicles.

Part of the globe-spanning Rheinmetall Group – also a major supplier of automotive components – Rheinmetall Defence has long been a prominent member of the international defence and security industry. As a top European supplier of army technology, they offer an extensive array of military hardware that enhances the mobility, reconnaissance capabilities, lethality and survivability of troops deployed in harm's way, and also enables the networking of national and international systems. Rheinmetall has spent years pioneering new technologies for protecting friendly forces, systematically expanding its range of products in this critical field.

RMMV offers several different military trucks, however my focus here will be on the "Extreme Mobility Truck System". This



Fajar takes a closer look at Rheinmetall MAN Military Vehicles (RMMV) which fit the battlefield and help to accomplish missions, wherever and whatever they may be with a wide range of trucks.

particular military truck has caught my attention because of the powerful looks that it has. The unique box-type frame's unique feature is its 100% torsion stiffness. The extremely torsion – resistant box frame with hollow longitudinal members and welded tubular cross-members makes the SX a class of its own. Its unique design allows the suspension to absorb even extreme terrain irregularities. The SX offers a stable driving experience even during fast off- road driving.

The secret behind the SX's extreme mobility and adaptability lies in its progressive coil- spring suspension with an extremely long spring travel path. Other highlights include the optional Hydro-pneumatic rear axle suspension with integrated, regulated, load-dependent shock absorbers-driving stability under even the toughest conditions.

The engine, cooling system and converter are combined in a compact power pack located behind and below the cab. With its unique off-road capabilities and torsion rigidity, the SX sets the benchmark in off-road mobility. It can even navigate terrain



NEW HX Range 6x6



HX 6x6 with MAC Cabin

normally only accessible to tracked vehicles. Leader in its class, the 3- or 4- axle SX is ideal for transporting high value, complex and sensitive systems such as tactical systems and weapons. The SX's solid, robust design reflects decades of experience in engineering extreme-mobility trucks.

It is primarily deployed as a carrier for sensitive weapons systems, since its boxed frame structure does not pass on any torsion, even when driving at full speed in difficult terrain. Carrying sensitive weapon could be quite a dangerous task for the truck. Therefore it has been through a lot of tests.

The term "Military truck" may sometimes be a bit misleading. I found that these vehicles are not only used during war, but they are typically also part of any preparation for crisis prevention, conflict management and peace keeping missions with a complex set of security challenges. Furthermore, it is usually being used for certain occasions such as parades or during Independence Day.



SX 45 8x8 Recovery

Mobility and flexibility are essential to guarantee rapid deployment to affected areas. Just as important is a perfect harmonized logistic and tactical support. Military trucks designed by Rheinmetall MAN are built for on- and off-road missions worldwide. They combine maximum mobility and reliability with great operating efficiency.

From desert sands to stone track, from mud and rubble to snow and ice, they climb steep gradients and ford deep rivers with ease. These mobility trucks offer excellent off road qualities on any surface to keep military crews on the move and protected.

Looking at these technical feats, it becomes clear to me that not all trucks are created equal as they are subject to different tasks and environments. For long distance haulage cabin comfort may be crucial while for military trucks protection is paramount. **T**



NEW HX 10x10



Hong Seng Group is big in Penang with Hohan trucks

Having been in business for close to 50 years, Hong Seng Group applies its distribution expertise to trucks as the management departs from the sunset industry of reconditioned vehicles and engines.

Along the highway to Penang is a vast plot of land which is sporting a huge showroom for Hong Seng Group. If the construction of this building is any indication of the ambition that the management has, then the Malaysian truck market will see some interesting developments. We met with Dato Teoh, Managing Director of Hong Seng Group, to get the insight scoop of what he has in store for his group.

Change is constant

While not a totally new product for the group, trucks are now much more in the limelight. "We started as importers of used engines. However, this is pretty much a sunset industry. This kind of business will shortly be dying. In order to ensure the continuation of our business, we were looking at alternatives" explains Dato Teoh. He gives the rebuild trucks another decade before the government will put a halt to them. With their vast experience in importation and distribution of goods, new trucks were the next logical step he explains the move. While the Hohan brand is currently the best-selling truck with the highest growth potential for Hong Seng, there are six other Chinese truck brands available from them.

Why Chinese trucks?

According to Dato XYZ, Chinese trucks have one big advantage: "Only China can deliver affordable trucks in the quantities we will

require." Hong Seng started with JBC and quickly added Hohan and Youngman trucks to their portfolio. In addition, CAMC, DongFeng and DFSK trucks are represented by the company.

The trucks are apparently "Simple vehicles that allow for easy maintenance. This is something our clients are asking for and with these trucks we have the answer to their calls" says Dato Teoh. as Chinese trucks are now widely available in Malaysia, the acceptance is there and clients do not see any problems with Chinese trucks any more.





Spare parts availability, fuel economy and the wide range of available models are further plus points for the Chinese brands these days. Hong Seng delivers some 2500 vehicles a year, all of which are assembled from CKD in their own plant where some 100 workers build them. "Trust me, the sales of Hohan trucks will go up!" Dato Teoh says with confidence.

Trust sells trucks

A family business since 1965, Dato Teoh joined the company as it was a natural decision. His view is simple, yet convincing as "It is a tough industry, granted. But at the same time, it is one that is evergreen. There will always be a need for transportation solutions. What we need to do though is to innovate and evolve with the market." Since the trucking industry never stops, his children have also joined the company and are following his footsteps.

The recipe for success is apparently trust. Since many companies have been in touch with Hong Seng for many years, there is a great rapport between them. Over the years, Hong Seng has gained the trust of customers, which has been the key to the successful introduction of Chinese trucks. When Chinese brands first entered the Malaysian market, there was little confidence in them. "However, we have the confidence to sell these trucks and as our clients trust us, they have given us a vote of confidence too by purchasing the truck brands we represent". This confidence of Hong Seng is reflected in the sales and distribution network as well as in the product range. "When you put a reputable name like ours behind a newly introduced product, customers will believe that it is goods as you wouldn't risk a name that you have built over decades" said Dato Teoh. Thanks to the great support of Hong Seng's customers, management has plans to add more Chinese truck brands to their portfolio in the very near future.

As the importer of the trucks, Hong Seng also bears the responsibility in case something goes wrong or a truck breaks down. Warranties and guarantees are Hong Seng's job and these again are riding on the reputation that has been built over time. Hong Seng's management believes it is the close relationship with clients that is the key to success.





Moments

Even though the company enjoys a great reputation, taking on the Chinese truck brands still bore some risks. It is therefore that the most memorable moment for Dato Teoh was when the first orders for the trucks came in. "It was a confidence boost and a very proud moment when we handed over the first China made trucks" he reflects.

As Malaysia is an open market, the trend Hong Seng sees is that there will be more Chinese brands entering the country. Dato Teoh goes on to say that the Chinese brands are to dominate the Malaysian market within the next five to ten years. The quality of the vehicles has been improving constantly and he attributes this to the increased confidence and sales numbers. Transporters now have a wide range of truck brands to choose from.

More than a showroom

To support the growth of the truck segment for Hong Seng, a new showroom was opened in August. This 5 000 square meter facility features the trucks, offers office space and is also a training centre, making this a 4S location. It is here where spare parts will also be stored. Room for expansion is planned into the facility to accommodate the additional brands the company plans to bring in.

"You need courage in this industry and a well structured sales and support network is key. Without these components, you are likely to fail" is Dato Teoh parting advice. 

Company overview: HONG SENG group

Hong Seng Group (HSG) is a leader in remanufacturing and rebuilding services in Malaysia. Since 1965, Hong Seng Group has been helping businesses in Malaysia and across Asia to succeed, powering their performance through quality products and reliable services. HSG has grown from an importer and dealer of new and old engines into a supplier of choice, expanding capabilities according to market needs to create outstanding products that deliver impressive results. Over the years, HSG has built a reputation based on trust - "we always deliver on our promises" is their motto.

Today, the HSG family of companies engages in:

- Remanufacturing industrial engines for marine and generator applications
- Rebuilding vehicles
- Rental of generators, air compressors and welding sets
- Dealership for agricultural machines, spare parts and new vehicles

As the business activities of each company in HSG are closely related to each other, this allows HSG to synergize strengths, expertise and resources to the competitive advantage of customers. The end results are swift, efficient service and exceptional products at lower than market prices.

United by the core values laid down by HSG's founder, Paul Teoh Teng Seng, HSG will continue to empower the operations of businesses across Asia.

Supercool™

Engineered For Safety

20,000,000

20 Million Tyres Retreaded With Supercool Premium Compound
That's a lot of trust.

Fleet operators in almost 60 countries worldwide rely on Supercool to get thousands of their truck drivers safely back home again after making their deliveries.

Why can you trust Supercool premium pre-cured treads to give outstanding performance and keep you safe on the road? Take a look at the unique Supercool features.

- **40% cooler**
- **30% better mileage**
- **20% higher chipping resistance**
- **Anti-avulsion abilities**
- **German technology used**
- **Less maintenance downtime**



GIIB
Engineered To Care

Goodway Rubber Industries Sdn Bhd (14722-D) (Subsidiary of Goodway Integrated Industries Berhad, a Malaysian public listed company)

T : +60 3 5632 9981 F : +60 3 5632 9980 E : marketing@giiworld.com www.giiworld.com



Arrived: on TNT's European Road Network

Asian Trucker checks into TNT's ERN headquarters in Holland where it seems we are getting to see the future of transportation in border-free economic zones.

It is reliability that matters first and foremost when it comes to guaranteed next-day deliveries. Bas Janssen, Managing Director TNT Express Road Network B.V. explains how the company achieves this by using the newest trucks, sophisticated planning and insights into consumer thinking.

The Trucks

"It is interesting to see that our trucks are getting younger and younger. The utilisation is continuously increasing, so our vehicles rack up kilometres very fast" says Janssen. According to him it is almost a scientific exercise to determine when exactly the trucks should be traded in. Currently, the fleet is about 4 years old with the trailers being between eight to ten years in service. "The reason for the longer running time of the trailers is simple: we may not always load them fully. Our trucks leave at precise times, not when the trailer is full" he explains. TNT owns a mix some 65 trucks from MAN, Volvo and DAF. Own trucks are used on all routes that require arrival in time to make the next trip from the hub. These are called "Connectivity Trucks".

Preventive maintenance and selection of vehicles with high durability is key to success. Naturally, fuel efficiency is a key factor, but the immediate consideration is the need for trucks that run daily without fail. The mix of trucks has to do with risk management as one would not want to put all eggs in one basket. Also, the trucks need to be packaged with service contracts. The "best combination of truck and maintenance" may vary from OEM to OEM at the different times of purchase.

As Janssen puts it, it is make or break for the business if the driver knows how to manage his right foot. However, if your promise is on time delivery all the time, then you need to ensure that the trucks are running. Maintenance is carried out by a third party service provider which is located opposite the yard, ensuring quick turn-around with little transits.

Trucks are monitored by GPS as we have seen this on the other road networks. Besides the scheduled maintenance, TNT goes the extra mile and sends the trucks for two annual inspections whereby it is only required once per year. Trailers are custom-built to meet the specific requirements of customers.

The Drivers

Similarly to the trucks, drivers are chosen based on their reliability. The company is always using the latest technology and equipment and a long line of drivers would love to work for TNT. The critical routes are handled by TNT's own drivers that will commute between 20 hubs in and deliver to 40 countries.

Drivers are allowed to steer a vehicle for 5 1/4 hours before they have to take a 45 minute rest. For teams of two drivers the maximum is 21 hours, after which a full 11 hour rest has to be taken. "Now, this means you have to park the trucks as close as possible to the loading bay. Every minute counts as driving time and should not be wasted with manoeuvring the trucks" says Janssen. In the ideal case, hubs are planned in geographic locations that would be about 21 hours apart with one crew handing over to another after their legally allowed driving time, thus keeping the truck on the road non-stop.



An internal competition is held on an ongoing basis and the most fuel efficient driver is featured in internal newsletters. As a result, truckers are proud of their achievement and are working toward winning the challenge, although it may not always be possible as the routes may have more or less hilly terrain.

The future

According to studies, the truck / road transport combination will still be the most cost effective for the next 50 years. TNT is constantly working on improving their uptime, load capacity and connectivity. Having one of the most extensive road networks for their deliveries is also putting obstacles in the way. Naturally, the free movement of goods across the EU allows to transport goods through members states easily. However, at the same time traffic has increased with more and more congestions coming up. The myth of the German Autobahn being a maximum speed track is long gone.

As Janssen explains, the truck is still be most cost effective and reliable way to transport goods. However, it is also the responsibility of courier and logistics companies to reduce emissions and impact on the environment. To achieve the "cleanest way" of moving goods, one needs to look at more than just the truck. Extra long trucks / trailers are one way of moving more with the same amount of trucks or even reducing the number of vehicles on the road.

The jobs handled

Apparently, nothing is too complicated to move for TNT. For the "normal" transport, goods should be a) packed properly (as moving goods may damage other consignments), b) movable



Mr. Bas Janssen, Managing Director,
TNT Express Road Network B.V.

by forklift and c) packed on palettes. In case the goods to be moved don't comply with these, the "Special Services" takes over.

The journey of Asian Trucker on TNT's road networks has now spanned some four issues and we have travelled 1 000s of kilometres. While the countries and conditions were widely different, there are two things that stood out as the key components: The drivers and the trucks. And with the idea of the ASEAN Free Trade Zone, we can be sure that Asian Truckers will continue to be in demand. **T**

Shell Heavyweight Challenge Finals in London



Finally, the Shell Heavyweight champion is crowned in a full day event in London UK. Fajar joined a media entourage to participate in the proceedings and to see how the Malaysian winners fare.



We have followed the Shell Rimula Heavyweight Driving Challenge from Johor Bahru to Port Dickson and now all the way to the final stage in London. The lucky six Malaysian winners heading to the finals were Mr Chang Meng Fei, 29, Alor Setar; Mr Khoo Teik Seng, 39, from Pulau Pinang; Mr Liau Chia Chin, 40, Miri; Mr Loh Yew Sing, 53, Sandakan; Mr Tan Chin Pang, 27, Miri; Mr Tang Chung Lay, 47, Sibul, who were representing Malaysia in the inaugural Shell Rimula Heavyweight Driving Challenge.

Global event

Present were the global finalists from 12 countries who put their heavy-duty driving skills to the test. Participants had to drive a range of heavy vehicles through a series of obstacles at the unique competition in a bid to be crowned the first-ever Shell Rimula Heavyweight Driving Champion.

"What we are trying to achieve here is to create a unique experience for everyone which money can't buy. It is not much about the competition, but we want everyone to have some fun

and gain something. Driving various ranges of heavy vehicles might be an once in a lifetime opportunity for some of the participants," said Caroline Missen, GM Marketing Transport and Industry Brands.

The media group

The media group, comprising of media from around the world, was given the opportunity to compete with them as well. Journalists had to complete exactly the same challenges as the contestants. Instead of just doing the coverage about the event, they were given the chance to experience it themselves.

"It was so entertaining to be one of the participants for the media group. I have to admit some of the challenges were quite tough for me but I managed to complete all of the eight challenges. Obviously, I never expected to be able to drive and control entire line-ups of heavy commercial vehicles, but with the help of the instructors, it was actually easy. Driving the prime mover and the dump truck are my favourite challenge," said Fajar, Writer of Asian Trucker Magazine after the event.



“At Shell, we also stand apart from the competition as a total lubricants solutions provider to fleet operators. We have a specially designed product and business solutions offering called “Driveline”. It comprises of a complete portfolio of technologically superior products to protect every driveline component against wear, acids and deposits: Shell Rimula heavy-duty diesel engine oils; Shell Spirax transmission, axle and gear oils; and Shell Gadus greases,” said Shell Rimula Global Brand Manager, Ms Seow Lee Ming.

Shell Rimula is committed to research and development, investing heavily to ensure its heavy-duty engine oils are tested in the world’s hardest working vehicles and driving conditions. It is these learnings that are then applied to benefit Shell Rimula customers and offer them the most advanced lubricant products available in the world for all heavy-duty vehicles.

The experience

During the challenge, guests experienced the vehicles’ power and gained an appreciation of the demands often placed on heavy-duty engines of tractors, excavators, dumper trucks, loader cranes, forklifts, articulated trucks and telehandlers when operating in real-life conditions – all protected by Shell Rimula heavy duty engine oil. Driver concentration and awareness were also put to the test in a number of precision and finesse driving challenges, as was the ability to work as a team to complete the various tasks.

The London adventure was not limited to activities behind the wheel. Guests were based in a luxury central London hotel from which they could explore the famous shopping streets and visit the iconic sights of the historic city. In the evenings they were treated to a little glitz and glamour at an array of exclusive dinners hosted by Shell Rimula.

At the finale of the unforgettable trip, the expert instructors revealed the competition winners at a dramatic prize giving where the overall World Champion was announced and the much anticipated winning nation was awarded to Thailand. **F**





YOKOHAMA
Industries
YOKOHAMA INDUSTRIES BERHAD
(292788-17)

In the business of starting your truck: Yokohama batteries

Yokohama today is a trusted name in automotive batteries in Malaysia, providing all JIS and DIN standard models for passenger and commercial vehicles.

Yokohama Industries traces its origins back to 1961, when it was founded as Tai Kwong Yokohama. In the beginning, the business was based on the reconditioning of used automotive starter batteries. Today, the company operates a cutting edge manufacturing plant that resides on 36 acres in Semenyih, Selangor. This integrated facility features an automated plant, well equipped Research and Development facilities and full engineering capabilities. It is renowned for automotive batteries and being the most modern battery manufacturer in the country. Yokohama Industries have been a Public Listed Company on the Malaysian Bourse since 1995. Along with its manufacturing facility, Yokohama also operates a lead & a plastic recycling plant in Pengkalan, Perak. Both plants are ISO 9001 and ISO 14001. The manufacturing plant is also TS 16949 accredited.

We visited the Yokohama plant and the marketing team took us along on a tour through the factory to get the inside scoop on Yokohama. One recurring question is about the name as it implies ties to the tire manufacturer from Japan. However, Yokohama is truly a Malaysian company and it was never related to the Japanese company. Yokohama has been operating for 47 years and it will celebrate its 50th anniversary in 2017. Domestic distribution of Yokohama batteries is carried out through Borneo Technical Co. (M) Sdn Bhd, which has 17 branches serving a nationwide base of 17,000 customers.

Of its annual production of two million batteries for cars, trucks and buses, over half its products serve Malaysians every day. The rest makes its way to local automotive OEMs & 40 other countries worldwide.

Batteries

For all intents and purposes, a battery is designed with the idea to start the vehicle and maintain the electrical use of the vehicle when the engine is switched off. In terms of physical sizes, a truck battery tends to be bigger than a car battery. Generally, the bigger the battery, the higher the capacity. A large truck usually operates on a 24 Volt electrical system, but in order to have 24 Volts, two 12 Volt batteries will be connected in series.

The voltage tells you the state of charge of a battery. Most people judge the condition of a battery by its voltage, simply because voltage can be measured, while capacity can't. However, what really matters is how much capacity and cranking amperes a battery still contain to start a vehicle. Your truck alternator should be providing 28 to 28.8 volts to ensure proper charging.

Facts

Alternators are used in modern automobiles to charge the battery and to power the electrical system when the engine is running. When your truck is not running but you are using the air condition or the radio, you will then use your battery power. Nowadays it is common to charge your gadgets, such as mobile phones, in the vehicle. The electrical supply of all the electrical components comes from the alternator if you run your engine. The alternator is designed to power all such items without drawing power from the battery. However, if you add gadgets (amplifiers, lights, etc.) you will add to the power consumption. Should one add gadgets, it is necessary to change the alternator to match the power consumption. Should the alternator not produce enough energy, then the battery will add the balance. Over time, this will result in the battery being drained.



The lifespan of a battery will vary considerably with how it is used, how it is maintained and charged, ambient temperature, and other factors. A truck battery tends to be used for a long duration, as some logistic companies operate around 20 to 22 hours per day. However, the age of the truck does not affect the battery. It depends on the state of the alternator, if the battery is protected from excessive shocks and if it is being maintained properly. If a battery is taken care of, it will provide cranking power for a long time. Therefore, it is essential for owners of the truck to be aware of the condition of the battery. Regular checks are a must if you want to avoid costly breakdowns.

As there are other brands in the market, one may ask what the difference between Yokohama products and others is. "Generally, availability, cost and brand reputation matters to consumers. At Yokohama, we build with quality as first consideration. Besides numerous quality checks during production, stringent testing that meets and exceeds international standards are conducted and repeated before product are approved for mass produced" said Dennis Yong, General Manager of Yokohama.

Factory Visit

To better understand the product, we have been led by the Yokohama team on a tour of their factory. Operators are well equipped with safety equipment and a clinic is provided within the factory area for general consultation and emergency cases. Integrated technology is used for better quality and as well as for environmental control. We were taken to the Research and Development Centre, where the entire range of test equipment needed for the battery is housed. Here, it is demonstrated how a battery is developed from the concept stage till the final product. The Centre for Electrical Research (CER) also leads and facilitates joint research programs with universities, institutions and industries to ensure that Yokohama maintains its position at the forefront of Malaysian and global technologies. 

How to take care of your battery



1. Check your electrical connections

Make sure the battery terminals and cable connections are clean and tight to enable proper current flow. Corrosion on the battery terminals can prevent a bus from starting by adding electrical resistance, so it is important to clean the terminals periodically using water and a wire brush. Ensure you wear the correct protective gear (gloves and eye protection) as the white powder (lead sulfate) is toxic if inhaled, ingested or comes into contact with your skin.

2. Keep batteries clean and dry

A dirty battery surface can lead to a discharge and corrosion. It is important to avoid spilling oil or grease onto the top of the battery.

3. Avoid draining

Avoid leaving vehicle accessories on regularly as this will discharge the battery which will then require a recharge. Constantly recharging may shorten the life of your battery.

4. Secure your battery

Check that your battery is secure at all times, as vibrations can damage the battery plates. Inspect battery terminals regularly; loose connections can cause breakdowns.

5. When to replace your battery

If the battery is too weak to provide a sufficient voltage to the starter, you'll hear a distinctive clicking sound and the engine won't crank over. This clicking indicates that the battery is not fully charged. Sometimes a faulty alternator will be the culprit, but other times the test will reveal a weak battery not capable of holding a charge. This means the battery must be replaced.

TIPS:

- You may have to reset your clocks and radio presets, since all battery power was lost.
- If your bus doesn't start after running fine, just hours before, it may be a problem with the battery. Usually it happens with an older bus with an older battery. Just putting in a new battery without cleaning the cable connector corrosion sets you up for the same exact problem all over again. Corroded material just keeps eating away forever, if you don't get it all.



Stay cool with Nanocool

Applying their invisible Windshield Protecting Film (WPF) to a light-duty truck, Nanocool's solution help you to avoid costly repairs of your windscreen.



The latest trial from Nanocool might give a giant impact in the market soon. Nanocool collaborated with Inokom by applying the WPF to an Inokom light duty truck. Nanocool is able to provide the highest level of comfort and protection to its customers through its various ranges of products. On offer is a wide range of window film for automotive and commercial use, each having different levels of transmittance and reflectance of solar energy, transmittance visible light, UV reflection and infrared reflection.

All Nanocool's film is certified by U.S Skin Cancer Foundation, Energy Star Program, International Window Film Association, and complies with ISO 9001 and 14001 standards.

The aim of applying this first WPF on truck is to demonstrate how truck owners can benefit from this simple application to reduce the risk of costly downtime. People in the industry certainly know that trucks are frequently used in a tough environment such as construction, off road, highway, rural area and others. This kind of environment brings with it a high potential of damage to the windscreen of the truck through stones hitting it. Even when travelling outside construction sites, there is always a chance that a stone is picked up by another vehicle and hurled against a truck. Damage to a windscreen will be costly to repair, besides forcing the truck into the workshop.



Invisible Windshield Protection Film

The screen protector used for this test has anti-scratch characteristics and anti-shatter qualities. The Invisible Clear Film is made of special 4 mm polymers that can withstand the impact equivalent to 100 foot pounds. Reinforced your truck's windshield will be more strengthened by up to 39% and the film reduces the possibility of fractures due to sudden impact.

- Protect windscreen surface against most external objects that may damage the windscreen
- Clear film provides clear visibility without any distortion
- 4 mm thickness, withstanding impact even from an impact of 100 ft/lbs
- Reduces sunlight heat up to 82% and UV protection up to 95%
- With ClearX HD solution, windscreen wipers works even more effectively and smoothly
- Easy to clean after installation and no residual stain after removal

"We are so thrilled about this experience with Inokom and are hoping it could be an eye opener for the industry as it is a long term saving benefit. We only produce high quality products, therefore we have no issue to guarantee it. We are very pleased to cooperate with Inokom and eager to work with other truck brands as well," said Judy Kong, Director of Nanocool Sdn Bhd.

Simple steps of WPF installation

The very first step is to measure the windscreen as the film needs to fit exactly. This is required in order to avoid excessive film usage. Next, the windscreen must be cleaned with water to remove dirt. Thereafter the windscreen has to remain wet as to smoothen the process of applying the film onto the screen. Lastly the team is using a heat gun after placing the film to bond the windshield film to the glass. The duration of the process only takes only about 30 minutes. **➤**

ZF Keeps the World Moving



Fredrik Staedtler, Head of ZF Commercial Vehicle Technology Division, at the ZF Trade Press Conference 2014

When Floyd Cowan went to Germany he got an inside look at how ZF Group, a global leader in driveline and chassis technology and a leading parts supplier, contributes to keeping the world in motion.

In a church in Aachen, Germany there is a small throne that is believed to be made from slabs of marble from The Church of the Holy Sepulchre in Jerusalem where the tomb of Jesus was believed to be. Charlemagne, who made his home in Aachen, and died there in 814, took these slabs and made the throne for Christ to sit upon when he returned. This is a work of art that could define the word unique. There is nothing else like it.

A Leading Company

ZF Group organised and sponsored my trip to Germany, along with journalists from a number of countries to test vehicles and learn about their operations. ZF is a global leader in driveline and chassis technology with 122 production companies in 26 countries. ZF is among the top 10 companies on the ranking list of the largest automotive suppliers worldwide. Founded in 1915 for the development and production of transmissions for airships and vehicles, today the group's product range has expanded to steering systems, chassis components and complete axle systems and modules.

Our hosts put us up in Aachen for a day as it was the closest major centre to the test track where we would get a close up experience with commercial vehicles. We had beautiful weather on the day when we got to explore the town with a local guide. In the evening we enjoyed the introduction dinner where we had the opportunity to meet with the management team and heads of Business Units. Frederik Staedtler, Head of CV Technology Division and Thomas Rosch, Managing Director of Openmatics were on hand and their welcoming speeches gave

us a brief introduction to ZF and what we could expect in the coming days.

Efficient Use of Resources

We were up early for the drive to the test track where Mr Staedtler hosted a press conference. In his keynote address he stressed the importance of innovation and value add within the commercial vehicle industry. "For fleet operators, commercial vehicles must be economical and reliable. They must use their resources as efficiently as possible.

"There are high cost pressures," Mr Staedtler continued, "but there are also huge opportunities which require innovation. Innovation cycles are getting shorter and shorter with new features growing quickly and more models coming on line."

The head of CV Technology outlined the mega trends that will influence the commercial vehicle industry: The need for reductions in CO₂, reliability, connectivity and energy efficiency. "We must reduce emissions while the vehicles must be more economical. Volatile markets strengthen uncertainty."

Economies of Scale

For ZF to be able to cope with these mega trends it must reduce development costs and time to market. "OEMs (original equipment manufacturers) are using multiple sourcing to meet their needs and they need economies of scale to be competitive. For suppliers they must provide high quantities that are high quality. They also must be close to the market.



ZF Ecomid manual transmissions for commercial vehicles on display at the ZF Trade Press Conference 2014

"ZF is a cost leader and a technology leader," Mr Staedtler added. "We are driving innovation and shaping future technologies. As we have done in the past, we continue to develop innovations."

The company must do two seemingly opposite things at the same time. "Added value comes from volume," Mr Staedtler stated, "but local production must design products for the local market. ZF, around the globe, develops products for the specific regional requirements."

A Global Approach

Focussing on new transmissions Mr Staedtler said they have to be lightweight for commercial vehicles and ZF takes a global approach to developing the technology and innovations for trucks and buses, but must still make adjustments for local markets. "We have made specific design-to-market solutions for the China market."

Following the press conference small groups went off to various stations for more in-depth sessions on specific areas such as a presentation on axle systems by Andreas Moser, VP for CV Technology, and we were given insight into ZF's approach to buses. The long-standing global trend towards urbanisation has given rise to new megacities, with existing cities growing rapidly. Traffic volumes are increasing along with associated noise and pollution.

Bus Rapid Transport

Recognising that sophisticated concepts for compelling public transport are required, ZF technology uses its resources to

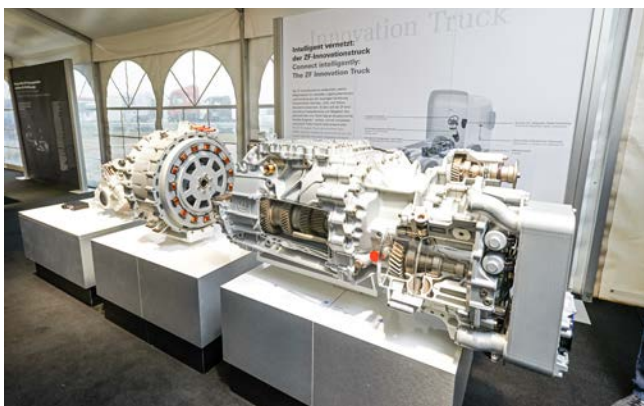

TraXon - The New, Modular Transmission for commercial vehicles from ZF at the ZF Trade Press Conference 2014

provide products and innovations that will meet these needs. For instance, the ZF-EcoLife automatic transmission for buses makes public transport not only more fuel-efficient, but also quieter. Engine speed can be kept low thanks to the intelligent design, six gears and the TopoDyn Life shift control system.

Low floor axles are decisive elements in a special transit concept – Bus Rapid Transit (BRT) systems. ZF chassis technology supports a continuous level, barrier-free floor and low vehicle floor height. As a result, boarding and alighting becomes more comfortable and much quicker for passengers – reducing the time buses spend at stops.

Silent Electrification

Then it was out into the rain to experience buses with ZF technology. We took a spin in Mercedes-Benz Citaro – Bus of the Year 2013 – with ZF's low-floor axle systems. Electrification in buses is an important trend and the TCV Sileo is a new player in this field. "A single electric vehicle can ferry hundreds, if not thousands, of passenger within local public transportation," asserts Stephan Rudolph, Sileo Electric Bus project leader. "Electric mobility delivers the greatest gains for quality of life while being economical."

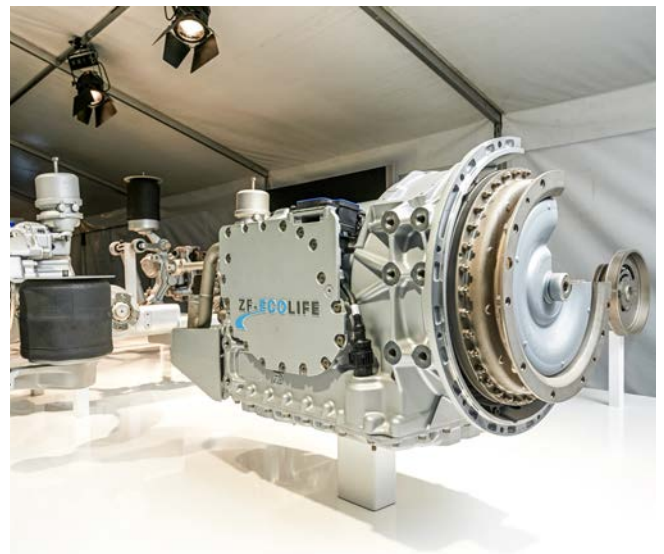

ZF-EcoLife automatic transmissions for city buses on display at the ZF Trade Press Conference 2014

Sileo, (Latin for silentium, meaning quiet or silence) is a Turkish-German coproduction. The body is from TCV (Turkish Commercial Vehicles) while the drive propulsion system and battery technology are from Germany. The lithium-ion batteries, which are mounted on the roof, provide 200kWh of usable energy. Prototypes have driven thousands of kilometres and its premiere is scheduled for IAA in Hannover.

Every component has been scrutinised and modified where needed to fulfil efficiency, lifecycle and comfort standards. This began with the rear axle, a ZF electric axle type AVE 130 with two asynchronous motors. The drive was designed by BC&C to ensure the best driving comfort, the highest operating efficiency and the ideal system integration. While initial test drives have resulted in high marks for the new bus, there are revisions to come – such as reducing the bus weight as it now is about 1,200kgs heavier than the corresponding diesel variant.



Test vehicles at the ZF Trade Press Conference 2014 in Germany transmission

TraXon

The TraXon, a modular transmission system, is a world innovation from ZF. With a completely new basic transmission and a modular concept, TraXon meets the demand of the commercial vehicle market for a versatile solution covering a broad range of applications. The innovative transmission combines several contradictions: It offers more torque, without compromising the power-to-weight ratio; it has a higher gear spread while the noise quality was improved; and, depending on the application, it can not only be driven by a dry clutch, but also by a hybrid module, dual clutch module, or a torque converter clutch.

For the new transmission ZF developed the revolutionary PreVision GPS shifting strategy which works in an anticipatory and especially fuel saving way thanks to the GPS connection and an interface to navigation data.

With the new, modular TraXon automatic transmission for commercial vehicles, a dual clutch module for heavy trucks is now available. With this module and the "Top 3" gearshift strategy, most gear changes can be performed under load and are barely perceivable. This is a special advantage for those trucks whose long rear axle ratio keeps the engine in a low speed range.

Test Drives

We were given the opportunity to drive loaded trucks with the TraXon automatic transmission to see for ourselves how smoothly it works. It does perform as promised.

Throughout the day we climbed in and out of many trucks to sit either behind the wheel or as a passenger. One thing was obvious as we drove many different brands was that some were more comfortable and had better sight lines than others. Good working conditions in commercial vehicles are no longer a luxury, but necessary in order to attract the best drivers, and getting vehicle and goods safely to their destination.

As a system provider, ZF develops and produces cabin suspensions for all applications in commercial vehicles – including springs and vibration dampers. For each, ZF offers



The TraXon hybrid transmission from ZF reduces fuel consumption by up to 15 percent in truck prototypes from Kamaz

the optimum solution tailored to the respective requirements. Drivers benefit from a more comfortable workplace with fewer jolts, pitching or rolling motions.

Driver Comfort

The CV Chassis Modules business unit within the ZF Commercial Vehicle Technology division develops and produces front and rear suspensions for the driver's cab to cover all common cabin designs. The front stabilizers that form part of the entire cabin suspension are delivered to many OEMs in volume production in welded or polygon versions.

For ZF, driver comfort is an on-going issue and they continue to produce new innovations. At the recently held IAA Commercial Vehicles 2014 ZF presented new solutions for the cabin suspension. One new system features an active roll stabilisation system on the front stabilizer. A special control unit, which receives signals on the driving conditions for sensors, controls the cabin suspension by means of a hydraulic actuator. The respective vehicle conditions are instantly recognised and the driver's cabin is then actively stabilised.

Finger Tip Control

At the end of a long day in the unrelenting rain, I found myself in the area in the centre of the test track, but this time looking at the truck from the outside. Still in the prototype stage a



ZF's AS Tronic lite automatic transmission system for light and medium commercial vehicles

truck, with a length of over 25m can be easily manoeuvred via a tablet remote control. Backing a semitrailer truck into a loading bay can be demanding, and dangerous.

Even experienced drivers can have problems making this manoeuvre, but I was able to do it at the first attempt. Backing the truck successfully into position is not the only benefit of this system. As the driver is outside the truck he can easily see the whole scene and any hazards around it. Thanks to the hybrid drive it also has zero local emissions.

The ZF Innovation Truck concept illustrated how OEMs, logistics companies and truck drivers could benefit from the integration of advanced transmission, steering and telematics systems. Challenges such as unpredictable waiting times at depots could be eliminated through autonomous steering manoeuvres.

A Winning Team

The rain continued on the long drive to Würzburg where we stayed overnight before taking the short drive Schweinfurt where we were to tour the ZF Services Logistics Centre and the ZF South Plant. Before we did that we had the opportunity to watch Germany destroy Brazil 7 – 1 in the World Cup. Despite the rain, no matter how late they stayed up celebrating, the next day the entire country was smiling.

While the football team would go on to win the championship there was also a feeling of being winners at the ZF plants we visited. Like the sports team there was a high level of efficiency as we witnessed parts being located in the massively big warehouse of the ZF Logistics Centre and moved to their distribution point. The largely automated warehouse was built in 1999. No people required as machinery moved material in and out of the 35m high storage area. Expansion continued in 2010 with another 45m high-bay warehouse coming on line with 26,500 storage spaces.

Where it Happens

The system is so efficient that a rush order received before 5:00pm can be delivered within Germany in the same day. There are 270 employees in the warehouse who work with computers

that give them all the information they need. Ongoing stock counting happens as parts get shipped and ZF Services Logistics Centre is able to support 700 shipments a day.

We then moved on to the Torque Converter Assembly plant where torque convertor gearboxes are assembled. In 2008, after three years of development, the first line was launched making 1 million torque convertors per year. In 2014 there are now six lines as one has been launched each year and 2.7 million units are now produced. On one line in 40 seconds one torque convertor is assembled.

In Aachen we saw how one product was valuable because of its uniqueness; at Schweinfurt the value is in the ability to produce exactly the same product a million times over at a very high quality level.

A Clean Operation

It is an impressive factory where the parts are even washed before being packed so they go out with less than 10% dirt in the convertor. While automation is essential to the operations the human factor has not been forgotten. One line has been adjusted to make it possible for handicapped people to work. The lunch room was also impressive with its modern feel and a variety of quality food available.

We had an hour in ZF's R&D Centre where we observed such activities as testing power trains, combustion engine testing, component testing, drive line tests, hydraulic test rigs, rotary tests, durability tests, tests that run 24 hours a day for seven days a week, shaking up and down tests, spinning tests, functional testing. We were told about tests of cars under many conditions, tests to check the interaction between components. Chassis noise is a big issue so there is a lot of work put into finding ways to reduce it. There are systems to test the specifics of a wheel under every possible condition. There were things moving so quickly that they looked like a slowly exposed photo – just a blur.

We saw many tests being performed, such as on the durability of clutches for commercial vehicles. Fully automated electronic



The ZF Innovation Truck integrates advanced transmission, steering, and telematics systems



Dr Stefan Sommer

test rigs operate 24 hours, seven days a week. It takes about 2-3 weeks to go through the entire lifespan of clutches for commercial vehicles. For passenger cars, it is only 3-5 days.

ZF produces millions of shock absorbers and we were shown various tests on the long-term durability of them. One two-week 24-hour test that they are put through is equivalent to a simulation of 200,000 km driven.

ZF Overview

Part of Dr Ulrich Walz's busy schedule was to brief us. The Member of the Board of Directors ZF Services gave us an overview of ZF's corporate structure, details of Business Unit ZF Services of which there are more than 2,800 employees and they are located in 77 of ZF's own locations worldwide. ZF has 650 service partners. While ZF already has a presence in Asia-Pacific the company is expanding in the region as it has identified it as a growth market along with North America. ZF

sees growth in its product portfolio, greater cooperation with "local stars", the development of new distribution channels and the development of remanufacturing and service activities as part of their long term growth.

Dr Walz noted that the spare parts business is the base of ZF's business. Remanufacturing, maintenance and repair are its strengths in the after sales market along with Workshop Concepts, Trainings, Logistics and Technical Information. For the aftermarket business, driveline and chassis technology, ZF uses well-established brands such as Sachs, Lemförder, Boge, ZF Lenksysteme and ZF Parts.

Speaking to ZF's Services Remanufacturing, Dr Walz noted that 95% recyclable material is used in ZF products and there is a 90% energy saving when remanufacturing a product in comparison with production of a new product. ZF and non-ZF products such as clutches, torque converters, steering systems and transmissions can be remanufactured. Warranty Claim and the inspection processes are the same as with a new part.

Impressively Growing

Having seen the operations, listened to management and staff and having the opportunity to see products in real life use, I got the impression of ZF as a very efficient and progressive company. They continue to innovate in the products they make, and innovate with the products and systems that help them produce their products and services.

ZF takes a long-term approach to innovation as Mr Staedtler mentioned at the opening press conference. Referring to the company's 2025 vision he stated, "How do we cope with challenges and face opportunities? We look at global megatrends that influence ZF and develop long-term innovation strategies. We look both at increasing efficiency and fuel economy. "

ZF is working towards growing their presence around the world. The company is big and getting bigger and those companies that compete with them will find that ZF is not only growing bigger, but stronger and more influential. **F**

PALFINGER

SERVICE CENTRE

Kempas Utama Industrial Park



ceasia

Connecting Europe to Asia

**CE ASIA HEAVY
MACHINERY SDN BHD**

www.ceasia.my



+6.016.7212179

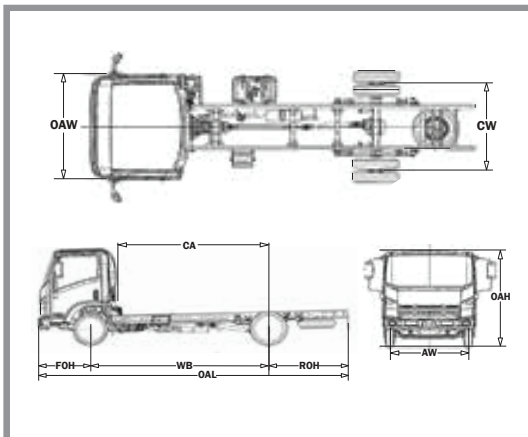

DIMENSIONS			NPR71 UHH	NPR71 UKH	NPR75 UHH	NPR75 UKH	NQR75 UKN	NQR75 ULN
Overall Length	OAL	mm	5,985	6,635	5,985	6,635	6,635	7,355
Overall Width	OAW	mm	2,085	2,125	2,085	2,125	2,125	2,125
Overall Height	OAH	mm	2,255	2,275	2,255	2,275		
Wheelbase	WB	mm	3,365	3,815	3,365	3,815		4,175
Front Overhang	FOH	mm	1,110					
Rear Overhang	ROH	mm	1,510	1,710	1,510	1,710		2,070
Front Tread	AW	mm	1,680					
Rear Tread	CW	mm	1,650					
Cab to Axle	CA	mm	2,795	3,245	2,795	3,245		3,605

SPECIFICATION SHEET		NPR PRO		NPR 150		NPR PRO	
MODEL CODE		NPR71UHH	NPR71UKH	NPR75UHH	NPR75UKH	NQR75UKN	NQR75ULN
Drive Train		4 x 2					
Wheelbase	mm	3,365	3,815	3,365	3,815	4,175	
ENGINE							
Model		4HG1-T		4HK1-TC			
Type		4-Cylinder In-line, 4-Cycle, Water-Cooled					
		OHC, Turbo		DOHC, Turbo with Intercooler			
Displacement	cc	4,570		5,193			
Maximum Output	kW (PS) @ rpm	92 (125) @ 2,850		110 (150) @ 2,600			
Maximum Torque	Nm (kgm) @ rpm	325 (33) @ 1,800		404 (41) @ 1,600 - 2,600			
Emission Level		Euro 2					
Fuel System		Direct Injection		Common Rail Direct Injection			
WEIGHT & CAPACITIES							
Gross Vehicle Weight	kg	5,000				8,500	
Curb Weight	kg	2,245	2,405	2,455	2,490	2,630	2,715
Front	kg	1,525	1,550	1,610	1,630	1,635	1,710
Rear	kg	720	855	845	860	995	1,005
Fuel Tank Capacity	l	100					
AXLE							
Front	Type	Reverse Elliot, I-Beam					
Front Axle Capacity (Design)	kg	3,100					
Rear	Type	Banjo, Full Floating					
Rear Axle Capacity (Design)	kg	5,000		6,600			
SUSPENSION SYSTEM							
Suspension	Front	Semi Elliptical Alloy Steel Leaf Spring with Double Acting Telescopic Shock Absorber					
	Rear						
TYRES & WHEELS							
Tyres		7.00R-16-10PR	7.50R-16-10PR	7.00R-16-10PR	7.50R-16-10PR	7.50R-16-14PR	
Wheels		5.50F-115	6.00GS-127	5.50F-115	6.00GS-127		
BRAKES							
Service		Drum Brakes with Dual Circuit Hydraulic Control, Vacuum Assistance and Load Sensing Proportioning Valve (LSPV)				Drum Brakes with Dual Circuit Hydraulic Brake Booster (HBB) and Load Sensing Proportioning Valve (LSPV)	
STEERING							
Steering System		Power Assist, Recirculating Ball Type					
Min. Turning Radius	m	6.30	7.10	6.30	7.10	7.80	
ELECTRICAL							
Battery		24V					
Alternator		24V-50A					

TRANSMISSION		Gear Ratio							
		1st	2nd	3rd	4th	5th	6th	Reverse	Final
NPR71UHH	5-Speed Manual (MYY-5T)	5.315	3.053	1.655	1.000	0.721	-	5.068	6.142
NPR71UKH									
NPR75UHH	6-Speed Manual (MYY-6S)	5.979	3.434	1.862	1.297	1.000	0.759	5.701	5.125
NPR75UKH									
NQR75UKN									
NQR75ULN									

WHEELBASE MODIFICATION		NPR71	NPR75	NQR75
NPR71UHH	mm	3,365	3,815	4,175
NPR71UKH	mm	3,815	4,175	4,600
NPR75UHH	mm	4,175	4,600	-
NPR75UKH	mm	4,600	-	-

ASIAN TRUCKER DRIVERS CLUB

UPDATE



PREMIUM SPONSOR:



Official Tyre Rescue Truck:



Bengkel Etika untuk ahli-ahli Kelab Pemandu Asian Trucker (ATDC)



Aktiviti kelab (ATDC) yang ke tiga, telah berjaya mendapat sambutan yang baik di kalangan para peserta.

Para peserta yang terlibat dengan bengkel etika ini adalah pemandu trak, pihak pengurusan dari beberapa buah syarikat logistik dan wakil daripada Kit Loong Tayar. Bengkel ini telah dikendalikan oleh Encik Ahmad Fauzan Othman yang merupakan seorang jurulatih "soft skills" yang bertauliah yang menjalankan latihan berfokuskan kepada topik-topik pembangunan produktiviti individu dan pasukan.

Kami menerima pelbagai maklum balas yang positif diakhir bengkel ini. Peserta-peserta yang terlibat tidak menyangka bahawa bengkel ini bukanlah suatu bengkel yang membosankan malah wujud beberapa aktiviti yang memerlukan pergerakan fizikal dari setiap individu. Aktiviti yang dijalankan adalah bagi mewujudkan komunikasi dan interaksi di kalangan peserta.

Kelab Pemandu Asian Trucker akan memperbanyakkan lagi aktiviti dimasa akan datang dimana ia mampu membina dan memantapkan jati diri sebagai seorang pemandu trak bagi mencipta satu identiti positif dimata masyarakat.



Pendaftaran Ahli Baru Kelab Pemandu Asian Trucker

Asian Trucker sentiasa bergerak dari satu tempat ke satu tempat bagi penambahan ahli kelab yang baru.



Pasukan Asian Trucker telah berada di Taipanco Wesport sebanyak dua kali untuk penambahan ahli kelab yang baru. Aktiviti ini telah mendapat sambutan yang baik daripada pemandu-pemandu trak di Taipanco dengan kerjasama pihak pengurusan Taipanco sendiri.

"Kami akan sentiasa bergerak mencari pemandu trak bagi mengaktifkan kelab yang ditubuhkan dan sentiasa bersedia memberikan pemahaman berkenaan manfaat yang diperolehi oleh ahli-ahli yang mendaftar," kata Stefan Pertz, Editor Asian Trucker.

Pasukan Asian Trucker akan bergerak ke beberapa tempat yang dirancang untuk penambahan ahli kelab dimasa akan datang. Segala maklumat dan kemas kini akan dikongsikan melalui akaun Facebook "Asian Trucker Driver Club"



Program Keselamatan dan Tanggungjawab Pemandu Trak Johor.

Program penambahan pengetahuan para pemandu trak bagi meningkatkan kesedaran diri dan memperbaiki identiti pemandu trak ke arah yang lebih positif.



Buat julung kalinya Kelab Pemandu Asian Trucker bakal berkerjasama dengan beberapa buah pihak iaitu "Johor Sand & Granite Lorry Operators' Association" (Persatuan yang menyediakan sokongan dan mengumpulkan para pemandu trak yang mengambil bahagian), "Truck Nation" (Lokasi/ Trak bagi ujian memandu dan pameran), "GILB" (Pembelajaran mengenai Tayar & Keselamatan), "Interlube" (Kepentingan Pelinciran), "Insurance TBC" (Kepentingan Insuran) dan sokongan daripada beberapa badan kerajaan bagi menjayakan program Keselamatan dan Tanggunjawab Pemandu Trak di Johor.

Program ini akan diadakan pada hari ahad, 2 November 2014 bertempat di Truck Nation Malaysia Sdn Bhd, Johor. Program ini akan disertai oleh 100 orang

pemandu trak dan akan dibahagikan kepada 10 kumpulan. Setiap syarikat yang terlibat akan mempunyai ruang pameran masing-masing dan mempunyai peranan tersendiri. Setiap peserta yang terlibat akan diberikan "punchcard" yang akan dicop pada setiap ruang pameran yang dihadiri bagi menjalani latihan/aktiviti yang disediakan dan peserta yang melengkapkan semua cop, akan menerima sijil.

Truck Nation telah mengambil inisiatif untuk mengadakan "Hari Pemandu Trak" di Johor Bahru bagi mengukuhkan lagi pengetahuan para pemandu trak mengenai keselamatan jalan raya. Program yang bakal diadakan ini, akan melibatkan beberapa buah pihak dan sekiranya program ini memberikan impak yang positif, ia boleh dijadikan sebagai program tahunan.

Bengkel Pengurusan Tayar yang kedua.

Penambahan ilmu berkenaan dengan pengurusan tayar dan sesi melawat kilang pembuatan tayar celup di Kit Loong Tayar Komersial



Sambutan yang begitu memberangsangkan pada bengkel pengurusan tayar yang pertama, Kelab Pemandu Asian Trucker telah mengadakan bengkel pengurusan tayar untuk kali yang kedua. Sekali lagi dengan kerjasama Kit Loong Komersial Tayar,

bengkel ini berjaya dijalankan dengan proses pembelajaran yang baik.

Bengkel pengurusan tayar ini adalah program yang berterusan untuk ahli-ahli Kelab Pemandu Asian Trucker. Program yang berterusan ini dapat memberikan

peluang kepada ahli-ahli kelab yang tidak dapat hadir pada bengkel yang pertama. Bengkel pengurusan tayar yang sama akan diadakan untuk kali ketiga pada bulan November dan berhasrat untuk menarik lebih banyak lagi ahli untuk hadir dan mengambil bahagian.

"Tujuan kami mengadakan bengkel yang sama untuk kali kedua kerana kami ingin melihat penglibatan dari para peserta, ternyata bilangannya bertambah. Kami akan terus mengadakan bengkel yang sama untuk kali yang ketiga," kata Stefan Pertz, Editor Asian Trucker.

"Kami kekal untuk berkerjasama dengan Kit Loong kerana Kit Loong adalah salah satu dari penaja Kelab Pemandu Asian Trucker dan Kit Loong juga banyak memberikan sokongan untuk meningkatkan keselamatan jalan raya. Kami sangat menghargai kerjasama yang diberikan oleh pihak Kit Loong. Secara amnye, perkara yang baik perlu dihebahkan untuk perkongsian ramai, dan pastinya Kit Loong akan mendapat lebih manfaat dari perkongsian ini," tambah Stefan Pertz.





MAN Truck and Bus (M) Raya open house and official opening of workshop in Johor Bahru





HINO Malaysia Hari Raya Open House - August 14



ASIAN
TRUCKER

COMMERCIAL
VEHICLE FINDER



In collaboration with:

 **Motor
Trader**

www.mototrader.com.my

in collaboration with:



www.motortrader.com.my



**COMMERCIAL
VEHICLE FINDER**



BACKHOE For Sale
 Import Recon Case580, JCB 214
 KOMATSU EXCAVATOR, KOBELCO
 SK200-6-4, EX200,SH60, SH120,PC150,
 PC 200, PC300, EX60, S280, EX120
 CAT910 Wheel Loader, HITACHI EX200-5,
 ZX130 With EX120, **RM-Call 012-
 6230289, 012-389036, (Loc. Senawang)**

00516233



**DAIHATSU HIJET '0'
DOWN PAYMENT**
 -, new body import from japan, rebuilt
 in Malaysia, new tyre, new seat, new
 aircond, new cd player, automatic &
 manual gear, **RM28,800 Call 019-
 3829102, 019-2303299, (Loc. OKR)**

00517003



DAIHATSU V116-HA BDM 5,000KG 2007,
 1-careful owner,tip-top, corrugated box 14 1/2 feet, sold
 in basic cond,first come first serve, **RM36,000 Call 012-
 2224490, 016-3235698, (Loc. Klang)**

00515910



DAIHATSU V58 UBS 12FT 2007, 1-Careful
 owner, Must view, Great Engine, Wooden Cargo,
 Original Condition, **RM36,800 Call 0193829102,
 0192303299, (Loc. OKR)**

00517029



DAIHATSU V58(4500KG) 2006, 1-owner,
 original paint, low mileage, smooth engine, nice
 interior, 100%acc.free, must view, **RM39,800 Call
 012-8881795, 019-3333155, (Loc. K.Lumpur)**

00515569



ERA JINBEI 14 SEATER 2014, 2.2L (P), 2.8 D/T
 high roof, long wheelbase, window-van, abs+ebd,rev.
 camera, d/blower, **FROM RM70,300 Call 016-6222163,
 012-2308686, 012-6511283, (Loc. SETAPAK)**

00516499



ERA JINBEI H2L 15 SEATER 2014, 2.5(P/D), high
 roof, long wheelbase, window van, abs+ebd, rev sensor,
 double-blower, **FROM RM92,800 Call 016-6222163, 012-
 6511283, 012-2308686, (Loc. SETAPAK)**

00516526



ERA KOMUTER 15 SEATER 2014, 2.5 diesel
 turbo (m), high roof, long wheelbase, window van,
 abs+ebd, luxuryseat, **FROM RM105,000 Call 012-
 2308686, 016-6222163, 012-6511283, (Loc. SETAPAK)**

00516518



**ERA KOMUTER BAS SEKOLAH 2.8 D/TURBO
(M)** 2014, 23 Murid-murid, high roof, long wheelbase
 window van,abs+ebd **FROM RM106,888 Call 012-
 2308686, 012-6511283, 016-6222163, (Loc. SETAPAK)**

00516535



ERA STAR PICK-UP ITON 1.3L PETROL (M)
 2014, aircond, cargo body, steel, box-van, lutan van,
 pasar malam, **FROM RM31,888 Call 012-6511283,
 012-2308686, 016-6222163, (Loc. SETAPAK)**

00516547



EXCAVATOR FOR SALE
 100% From Japan Model-S265-fa-l2,ms
 120-8.pc 200-5.ex 200-1,s2800-fa long
 am,roller sd 100, **CALL FOR BEST
 PRICE Call 019-265 0984, 016-229
 0984, (Loc. B.Caves)**

00516331



FORD MAXI 2.5 DIESEL 2003, Red, Well
 maintained, 14" S/Rims, Full Seat, Bas Sekolah,
**RM CALL FOR BEST PRICE Call 019333262,
 0123991819, (Loc. Segambut)**

00515963



HICOM MTB 145 (4500KG) 00/06, 1-owner,
 smooth engine, limileage, 100% acc-free, must view,
 stainless steel, floor board, original paint, - **Call 012-
 8881795, 019-3333155, (Loc. K.Lumpur)**

00515566



**FOTON VIEW 2.8 DIESED
SEMI-PANEL VAN**
 NEW, New, 5 seater, High offer, Welcome
 to Test Drive, - **Call 019-3617127, 012-
 3331189, (Loc. OKR)**

00516862



HICOM MTB 150 DXL(5000KG) 2005, 1-owner,
 17' feet long body, new paint, smooth engine, nice
 interior, 100%acc-free, must view, - **Call 012-8881795,
 019-3333155, (Loc. K.Lumpur)**

00515572



HICOM PERKASA MTB 140 4000KG 2002,
 Luton van, Sell as its basic condition, worthy to buy,
 good condition, **RM23,000 Call 012-2224490, 012-
 31123113, (Loc. Klang)**

00515426



HINO RKJ 2008, Clean Interior, DVD/TV, Well
 maintained, Accept trade-in, 40 Seater, Bas Persiaran,
 Loan arrangeable, Air-Conditioned., **NEGO Call 012-
 3991819, (Loc. Segambut)**

00515961



HINO WU300R BDM 4,800KG 2009,
 Corrugated Box 12 1/2 ft, Nice condition, few unit to
 choose. Worth to buy., **RM5X,000 Call 012-2224490,
 016-3235698, (Loc. Klang)**

00515661



INOKOM LORIMAS(BOX) 2002, new paint,
 smooth engine, 100%acc.free, nice interior, t/top
 cond, must view, **RM1X,XXX Call 012-8881795, 019-
 3333155, (Loc. K.Lumpur)**

00515552



ISUZU LORRY NHR55E 1995, new wooden
 body, clean interior, good condition., **RM14,500 Call
 017-3617127, (Loc. OKR)**

00516857



ISUZU ARM ROLL
 -, Unregistered, High Loan, Low Interest,
 MADE in japan, rebuild in malaysia,
**RM82,800 Call 019-3829102, 019-
 2303299, (Loc. OKR)**

00517000



ISUZU NHR 69 DOUBLE CABIN
 -, Unregistered, low D/Payment, Top, make in japan, rebuild in malaysia, body 10feet, **RM5X,XXX Call 019-
 3829102, 019-2303299, (Loc. OKR)**

00517006





ISUZU NHR(1 TON) 93/96, 1-owner, smooth engine, original good running cond, 100%acc.free, value buy, must view, **RM1X,XXX** Call **012-8881795**, 019-3333155, (Loc. K.Lumpur)

00515567



KOBELCO For Sale -, SK200-6-4, EX200, SH60, SH120, PC150, PC200, PC300, EX60, S280, EX120, Cat910 Wheel Loader, **RM**- Call **012-6230289**, 012-3890036, (Loc. Senawang)

00516236



ISUZU NPR 97/96, 31 seaters, fully refurbish, call for best price, loan arrangeable., **NEGO** Call **019-3333262**, 012-3991819, (Loc. Segambut)

00515966



ISUZU NPR 71 WOODEN BODY 17 FEET

-, Unregistered, Made in Japan, rebuild in Malaysia, new facelift, **RM68,800** Call **019-3829102**, 019-2303299, (Loc. OKR)

00517030



ISUZU NPR 81 DOUBLE CABIN 14 FEET

-, Unregistered, High Loan, Low Interest, Made in Japan, rebuild in Malaysia, **RM**- Call **019-3829102**, 019-2303299, (Loc. OKR)

00517010



KOMATSU PC200-5 -, Import recon case 580, JCB 214 KOMATSU EXCAVATOR, HITACHI EX200-5, ZX130 WITH EX120, **RM**- Call **012-6230289**, 012-3890036, (Loc. Senawang)

00516235



MITSUBISHI CANTER (4500KG) 2004, 1-owner, new paint, low mileage, original tiptop, smooth engine, 100%acc.free, must view, **RM3X,XXX** Call **012-8881795**, 019-3333155, (Loc. K.Lumpur)

00515570



MITSUBISHI DELICA 1996 2.5 DIESEL 1996, Red, Acc. Free, Clean Interior, Well maintained, 7 Seater, Loan Arrangeable, **RM NEGO** Call **0123991819**, 0193333262, (Loc. Segambut)

00515964



NISSAN C22 (WINDOW VAN) 1997, 1 Owner, new paint, smooth engine, acc-free, nice interior, value buy, must view., **RM1X,XXX** Call **012-8881795**, 019-3333155, (Loc. K.Lumpur)

00515688



NISSAN C22 1.5 2007, Clean Interior, Must view, Well maintained, ngv gas tank., **RM28,800** Call **016-3606727 MR CHANG**, (Loc. Selayang)

00516965



NISSAN C22 1.5(M) PANEL VAN 07, 1-careful owner, acc-free, must view, well maintained, many spec to choose, **RM26,800** Call **017-3866643**, 016-3368023, (Loc. Serdang)

00515831



NISSAN C22 1.5(M) SEMI PANEL 2007, 1-Careful owner, Acc. Free, Low mileage, Must view, Tiptop, new paint, **RM25,800** Call **019-3911333**, 016-3363126, (Loc. Kajang)

00515606



NISSAN C22 1.5(M) SEMI PANEL 99/2006, 1-careful owner, acc-free, low mileage, must view, well maintained, **FROM RM15,000** Call **017-3866643**, 016-3368023, (Loc. Serdang)

00515834

NISSAN C22 VANETTE



91/10, largest & specialist in vans, all new paint, full spec, fully refurbished, opposite sek, teknik with blue signboard, **RM1X,XXX** Call **012-2867842**, (Loc. Sg Buluh)



00516536



NISSAN C22 1.5(M) WINDOW VAN 96/04, must view, smooth engine, good running condition, **FROM RM16,000** Call **016-3368023**, 017-3866643, (Loc. Serdang)

00515829



NISSAN CD450 BDM 24,000KG 2008, 10 Tyre-Kargo AM(30F) with steel railing, nice condition, worth to buy, **RM10X,000.00** Call **012-2224490**, 016-3235698, (Loc. Klang)

00515559



NISSAN CMF (31 SEATERS)

1995/97, window bus, fully refurbish, loan arrangeable., **NEGO** Call **012-3991819**, 019-3333262, (Loc. SEGAMBUT)

00515967



NISSAN JA 2002, Must view, Accept trade-in, aircond bus, 44-seater, bus persiaran, engine converted to Nissan V8, loan arrangeable, **NEGO** Call **012-3991819**, 019-3333262, (Loc. Segambut)

00515959



NISSAN JP 2008, aircond, 44 seaters, new paint, loan arrangeable, acc.free, accept trade in, **NEGO** Call **019-3333262**, 012-3991819, (Loc. Segambut)

00515958



NISSAN LKA211N BDM 11,000KG 2005, Armroll Mechanism sell as basic condition, **RM5X,XXX** Call **016-3235698**, 012-2224490, (Loc. Klang)

00515658



NISSAN URVAN (D) 2007, Clean Interior, Excellent condition, Well maintained, aircond, loan arrangeable, call for best price, loan arrangeable., **NEGO** Call **019-3333262**, 012-3991819, (Loc. SEGAMBUT)

00515960

in collaboration with:



www.motortrader.com.my



NISSAN URVAN 3.0(M)(D) PANEL 2011, White, 1-careful owner, acc-free, clean interior, excellent condition, like new, low mileage, must view, well maintained, **RM55,800** Call **016-3368023**, **017-3866643**, (Loc. Serdang)

00515841



NISSAN VANETTE 1.5(M) LUTON VAN 2004, pasar malam box van, good condition, smooth engine, must view, well maintained, **RM27,800** Call **017-3866643**, **016-3368023**, (Loc. Serdang)

00515781



NISSAN YU41H5 2005, Must view, New Tipper Body 14 Feet, Low Deposit High Financing. Worth To Buy, **RM5X,000 NEGO** Call **0122224490**, **0163235698**, (Loc. Klang)

00515562



NISSAN YU41T5 BDM 5000KG 2006, Refrigerator Box with Thormorking unit(chiller), Length 16' Very nice condition, View to believe, **RM6X,000.00** Call **012-2224490**, **016-3235698**, (Loc. Klang)

00515558

REBUILT SCANIA VOLVO ERF



P94, 114, 124, 144, 164, FM12 Version 2, FM10 ECT 11, Must View, **RM1XX,XXX NEGO** Call **010-700 1000 Mr.Marco**, (Loc. Klang)

00515446



PERODUA RUSA 1.6(M) 1997/2008, Excellent condition, Many extras, Must view, Well maintained, smooth engine, best buy, **FROM RM11,000** Call **017-3866643**, **016-3368023**, (Loc. Serdang)

00515787



RENAULT KANGOO 1.4L SEMI PANEL 05, Emas, 1-Careful owner, Acc. Free, Low mileage, Original paint, immaculate condition, **RM12,800** Call **019-3911333**, **016-3363126**, (Loc. Kajang)

00515608



TOYOTA DYNA 2.5 DIESEL 1994, Clean Interior, Must view, lori rigid., **RM18,800** Call **016-3606727 MR CHANG**, (Loc. Selayang)

00516973



TOYOTA HIACE 2.5 1996, Clean Interior, Must view, Well maintained, panel van., **RM19,800** Call **016-3606727 MR CHANG**, (Loc. Selayang)

00516968

TOYOTA HIACE



92/06, Clean Interior, Tiptop, Well maintained, Accept trade-in, Call for best price, Ready Stock, largest & specialist in vans, all new paint, full spec, full refurbished, Sri Gombak 96 Auto City, **RM2X,XXX** Call **012-3725615**, (Loc. Sri Gombak)

00516533



TOYOTA HIACE 2.5(M) TURBO DIESEL 06/09, White, ABS, Acc. Free, Clean Interior, Airbags, Seater, CD player, Loan Arrangable, **NEGO** Call **019-3333262**, **012-3991819**, (Loc. Segambut)

00515965



TOYOTA LI-ACE 1.8 DIESEL 1996, Clean Interior, Must view, Well maintained, semi panel van, double air cond., **RM13,800** Call **016-3606727 MR CHANG**, (Loc. Selayang)

00516979



TOYOTA LY DOUBLE CABIN LUTON

-, Unregistered, high Loan, low Interest, make in Japan, rebuild in Malaysia, **RM4X,XXX** Call **019-3829102**, **019-2303299**, (Loc. OKR)

00517028



VOLVO FM12 BDM 36,000KG 2010, Must view, prime mover 2nd generation and trailer kargo AMI 41 feet double AX, **RM15X,000NEGO** Call **012-2224490**, **016-3235698**, (Loc. Klang)

00515564

First Apollo Zone inaugurated in Kuwait



Aimed at increasing sales and visibility in this high growth market

Apollo Tyres, a leading tyre major, made further inroads into the Kuwait market with the opening up of its first branded retail outlet in the

country. Christened as Apollo Zone, this outlet is designed to provide customers with an enhanced retail experience and a better feel for the brand and products on display, including passenger car, 4x4 and light truck tyres. This Apollo Zone is located in the up-market Canada Dry Street of Kuwait, and is operated by Federal General Trading & Contracting Co.

The Apollo Zone was inaugurated by His Excellency Shri Shubashish Goldar, Deputy Chief of Mission & Chief Public Information Officer and Dr Sushil Kumar, Second Secretary (Political, Economic & Commercial), Embassy of India, Kuwait. Also present on the occasion was Satish Sharma, President, Asia Pacific, Middle East & North Africa (APMENA) region, Apollo Tyres Ltd.

Commenting on the inauguration, Satish Sharma, President, APMENA Region, Apollo Tyres Ltd said, "We see a lot of potential in the entire Middle East region, including Kuwait, where the growth is

being witnessed in the high end and mid-segment cars. We would like to create a space for ourselves in the Kuwait market, which has a size of 75000 to 85000 passenger vehicle tyres a month. Branded retail outlets, such as the one which we have opened today here in Kuwait, will help us increase visibility for the Apollo brand, and will also result in a better and informed buying experience for the consumers."

After Dubai, this is the second branded retail outlet by Apollo Tyres in the Middle East region.



DongFeng Commercial Vehicle Malaysia conducts road show in Kota bahru

The event was held over the weekend of 29th August at DongFeng Commercial Vehicle Malaysia's dealership, Ah Yew Motor Works in Kota Bharu, Kelantan. More than 120 customers and potential customers were invited from as far as Tanah Merah.

Ah Yew Motor Works is providing spare parts and full services for DongFeng trucks in Kota Bharu and its surrounding towns. Their service team consists of three foremen and seven mechanics are trained by DongFeng Commercial Vehicle Malaysia.

Five different models of DongFeng trucks were on display. They were from the premium range of prime movers from Kinland 420 6X4 to fuel-saving Kinland 375 4X2. The rugged rigid truck T-lift 375 6X4 and value for money Kingrun 270 4X2 were highlighted during the event.

On hand to welcome the guests were Mr. John Foo Tai Jong, DongFeng Trucks Aftersales Manager and Mr. Teo Liong Tim, owner of Ah Yew Motor Works. Product presentations were the order of the day. Guests were briefed on the latest DongFeng technologies and how

different DongFeng trucks are matched for different applications.

During the event, eight units of DongFeng trucks were sold. Taking the lead was Mr. Ang Soon Hong, Executive Director of Ang Kim Lin Group who signed three units of Kinland 375 6X2 on the same day for their fleet. "After checking out the specification and quality of different China trucks, I decided to purchase DongFeng Trucks only" said Mr. Ang. "This is the first China made trucks that my company purchased" added Mr. Ang.



Volvo upgrades Kuching dealership



The Kuching dealership has also undergone extension upgrades and renovation. It can now fit up to 7 trucks are one go thus making them more capable of meeting all the needs of the local truck users. The list of equipment and tools available has also been expanded making repairs and service more efficient and of the highest quality. These tools also contribute towards shorter duration's a truck is in the workshop. Volvo Trucks Malaysia strives to keep upgrading their services to serve customers better. Drop by the Kuching workshop to learn more:

Lot 1017, Section 66, KTLD, Jalan Kilang, Bintawa, 93450 Kuching, Sarawak.
Tel: 082-330 131 / 082-482 866
Fax: 082-333 387/ 082-346 195 (parts)

Keltruck and Scania provide wedding transport for Smiths director



New Scania R620 8x4 gets to the church on time

Keltruck, the largest independent Scania dealer in Europe, has supplied a Scania R620 8x4 to Smiths Heavy Haulage a specialist in servicing commercial vehicles, cranes and earth moving machines. Smiths Mechanical Services is a family business run by Simon Griffiths and his parents, John and Sharon.

In a demonstration of his faith in the new Scania unit's reliability, Simon Griffiths used the truck to travel to his wedding in the Welsh town of Pendoylan. Yes, it did get him to the church on time – and in style.

Simon Griffiths, director at Smiths Mechanical Services, said, "My best man drove me to the church in the Scania – we needed to get there punctually, and the truck delivered. He then drove the unit to the reception at a nearby hotel."

The R620 is the first Scania truck that Smiths has bought after operating another manufacturer's unit for several years. It will run out of the company's Bridgend depot, and will work throughout the UK, moving heavy plant and machinery.

"We came back to Scania mainly due to our excellent relationship with Keltruck, and in particular with Andrew Long, their regional general manager," says Griffiths. "Keltruck's service is first class, and they have the same values as our family run business."

"Specifically, we chose the R620 because we were impressed with its manual gearbox and the fact that the configuration was already type approved," continues Griffiths.

Andrew Jamieson, managing director at Keltruck, said, "Using the R620 for his wedding is a great demonstration of the passion behind the brand and just how the family values of Smiths, Keltruck and even Scania come together."

The R620 8x4 ordered by Smiths has a load capacity of 150 ton, making it able to deal with the toughest jobs. The Scania R-series is designed to the highest standards of fuel economy, driver appeal and reliability. The series offers the widest choice of powertrain options, so it can be configured to fit any needs.

New Managing Director for Goodyear Malaysia

Goodyear has named Varinderjit Singh as managing director, Malaysia, effective July 8, 2014. He succeeds Ivy Peng, who has been appointed to a new ASEAN cluster role to lead growth and sales initiatives.

Varinderjit brings over 24 years of general management, sales and marketing experience stemming from careers with companies such as Samsung, Dell, NEC, 3Com, AMP and Mesiniaga. Most recently, Varinderjit held the position of vice president of Samsung's Enterprise Business in Malaysia. Prior to this, he was managing director for Dell in Malaysia and Singapore.

Varinderjit will be responsible for all areas of the Goodyear Malaysia business, ensuring that it achieves consistent growth of top line revenue and bottom line earnings, and delivers on the goal of creating sustainable economic value by being first with customers, the leader in targeted segments, the innovation leader, and competitively advantaged.

On his appointment, Varinderjit said, "Goodyear is a global leader in the tire and automotive industry and I look forward to expanding our footprints here in Malaysia as we continue to deliver meaningful innovations to our customers, fuelled by the passion of our people and partners."

Asian Trucker online survey results

Here are the results of recent quick polls we have run on our website.

Please visit www.asiantrucker.com to cast your vote for the latest poll.

Snap Poll

Should Malaysia Implement Euro 4 Emission Standards?

Yes, by end of this year - 28.6%



Yes, by mid next year - 42.9%

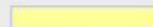

Yes, but only in 2018 - 14.3%



No - 14.3%



The voting for this poll has ended

To address driver shortages, would you hire female drivers?

Yes - 66.7%



No - 5.6%



Yes, but no overnight trips - 16.7%



No, can't allow mixed crews - 11.1%



MAN Focus on Safety Gains Ground in Middle East with 54 % increase in ProfiDrive Training

700 drivers trained over last 2 years, customer and driver education expanded to raise safety standards.

MAN Truck & Bus Middle East's focus on raising safety standards for Middle East customers is now seeing increased interest from customers with fleet owners and drivers taking part in more ProfiDrive training in response to increased awareness about the benefits of such situational driver training courses to raise the standards of safety on roads. MAN has seen a growing surge of interest from customers with 54 % increase in ProfiDrive training in 2014 as compared to 2013. More than 700 drivers have been trained by MAN over the last two years through ProfiDrive training conducted across the region.

MAN's ProfiDrive training is a specialized training programme designed to raise the level of knowledge so that drivers can adopt the best driving practices. In a one-day seminar, they learn predictive driving techniques such as how to

recognise dangerous situations, calculate the optimum stopping distance and evade obstacles that suddenly emerge. MAN has been offering the service to its customers in the Middle East for on-road operations since 2009 and recently expanded its scope by launching its new off-road training module to cover all aspects of truck operation in the region. In addition to having its own certified trainer for ProfiDrive, MAN is now also assisting customers with large fleets to have their own in-house trainer for their dedicated requirements.

Dr. Richard Brown, Head of Product Management MAN Middle East said, "We see a growing awareness among our customer base about the benefits of raising safety standards and as a result, they see immense value in taking part in our ProfiDrive training. The most effective accident prevention system is behind the steering wheel – the driver. It is important for the driver to drive with foresight, remain calm and confident in critical situations, and stay in control of

the vehicle. Driver errors typically cause more than 90 percent of accidents. Our ProfiDrive training has been specifically designed to enhance driver skills and the growth in demand for ProfiDrive as well as repeat sessions points to the effectiveness of such training."

While driver training is an essential component, MAN has also been communicating the importance of proper vehicle maintenance with customers to keep their vehicles in the best condition to maintain safety standards. In addition to this, the importance of genuine spare parts in maintaining safety is also another factor that MAN has focused on in its discussions with customers.



ZF Meet & Greet

- The meet & greet session started from 10.45am to 11.45am and proceed to Q&A sessions for 10 minutes.
- Mr. Siew Chee Kok, Managing Director of ZF Sales & Service (Malaysia) Sdn. Bhd. presented the topics and key figure of ZF Friedrichshafen AG, ZF Services and ZF Sales & Service (Malaysia) Sdn. Bhd and ZF Ecolife.
- After playing the ZF Ecolife video the presentation continued by Mr. Cheah Chee Luen, General Manager of ZF Sales & Service (Malaysia) Sdn. Bhd. and his topics is Expansion of Asian range.
- Mr Glenn Todd, General Manager of ZF Chassis Systems Sdn. Bhd. presented the topics about Car Chassis Technology Division and others.

From Mr. Siew Chee Kok; (please refer the slides for more details)

A) ZF expected have "high single digit" growth for 2014 in ZF Group globally.

B) ZF is an enabler of the Malaysian public transport network. There are more than 1,000 city buses fitted with ZF automatic

transmissions operating in Selangor, Kuantan, Kuala Lumpur and Penang.

C) EcoLife stands for being Ecological and Economical optimized for longer service life. Some of the benefits include:

- Better performance and fuel efficiency
- Reduced emissions
- Lower maintenance costs i.e. longer oil change interval
- Lower operational costs i.e. longer brake lining usage
- Increased comfort for passengers and less noise pollution

From Mr. Cheah Chee Luen;

(please refer the slides for more details)

We currently have 500 new references in the market and will look to launch another 500-700 new Asian range application (Proton, Perodua, Japanese vehicles, Korean vehicles and others applications) in the next two years.

From Mr. Glenn Todd; (please refer the slides for more details)

ZF Chassis Systems Sdn. Bhd, Kulim Plant established on 12th September 2012 and have 1st delivery of F10, F30 complete Axle to BMW/ Inokom on 2nd May 2013.

Volvo launches gas-powered truck

FE CNG

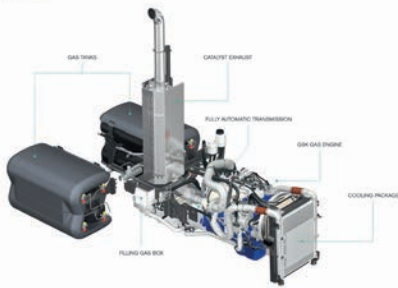

Volvo Trucks is expanding its model range in Europe with a new version of the Volvo FE running entirely on methane gas. The Volvo FE CNG (Compressed Natural Gas) has been primarily developed for operations involving short driving cycles with repeated starts and stops such as refuse collection and local distribution. It is equipped with a new 9-litre Euro 6 gas-powered engine featuring spark plug technology and automatic transmission.

"With the Volvo FE CNG we can now offer companies that drive a lot in urban environments a truck with a far lower environmental impact. Many cities the world over are looking for alternatives to diesel-powered trucks. In the field of refuse handling in particular, renewable fuels are often a requirement for securing a purchase contract," says Christina Eriksson, Business Manager Alternative Drivelines at Volvo Trucks.

Methane gas is odourless when combusted and it contains very low levels of harmful particles. If the methane is a biogas, that is to say based on organic materials, emissions of carbon dioxide are up to 70 per cent lower than those of a diesel truck.

The Volvo FE CNG is powered by an all-new 9-litre Euro 6 engine featuring spark plug technology that produces 320 hp and 1356 Nm of torque. "Spark plug

technology is particularly suitable for driving cycles where the truck covers short distances with a lot of start-stop traffic," explains Christina Eriksson.

Thanks to its fully automatic transmission, the truck retains the same excellent driveability and productivity as the conventional Volvo FE. The automatic transmission also gives faster driveline response. "Methane gas is the fuel that will become a sustainable alternative to diesel in the long term. Right now the focus is on working together with the various public authorities and private corporations to draw up the relevant rules and create the right preconditions for positive development," says Lars Mårtensson, Environmental Director at Volvo Trucks.

Sales of the new Volvo FE CNG will start in Europe in August, with series production getting under way in early 2015.

WABCO Expands Its Fleet Management Solutions Business With Major Deal in Saudi Arabia; Delivers on the Promise of Transics Acquisition

WABCO Holdings Inc. announced that its newly acquired fleet management solutions (FMS) company, Transics International, signed a groundbreaking contract with Saudi-Arabia based Almarai, one of the world's largest dairy companies. The contract marks the dynamic global expansion of Transics, a market leader in Europe, after WABCO acquired the company in February 2014.

Transics will equip Almarai's entire long-haul vehicle fleet of more than 1,300 trucks with its industry-leading fleet management system, thereby, helping the food company to further enhance its fleet's safety performance and operational efficiency. Starting in August 2014, Transics will upgrade Almarai's trucks with advanced TX-SKY on-board computers and install its web-based back office system TX-CONNECT for efficient truck, driver, trailer and cargo management. Transics expects to furnish Almarai's entire fleet of long-haul trucks by the second quarter of 2015.

"As a result of WABCO's strategic acquisition of Transics, customers can leverage the powerful combination of Transics' fleet management solutions

with WABCO's commercial vehicle systems expertise, industry-leading safety and efficiency technologies and global reach," said Nick Rens, President, Trailer Systems, Aftermarket and Off-Highway Division.



Transics' Fleet Management Solution will enable Almarai to monitor its entire fleet of trucks in real time, using valuable information on location, route adherence, vehicle speed and delays to support key operating decisions. In addition, the system captures data on driver behaviors such as braking, speeding, signaling and evasive maneuvers. The Transics' solution now means that Almarai has a direct link between trucks, drivers and its home office. Furthermore, Transics' FMS offering seamlessly integrates with Almarai's own transport management software (TMS).

FUSO's Diamond Contest 2nd Mini Draw



Held on the night of the 5th of September, the second Mini Draw saw some 200 customers and distributors of FUSO trucks. Customers were hoping to go home with holiday vouchers worth up to RM 20 000.

"The "FUSO Diamond Contest" has been initiated in 2006 as an acknowledgement of the growing customer base" said Mr. Folger, President of Mercedes Benz Malaysia, during the event. In this draw, 13 lucky winners walked home with parts and holiday vouchers worth RM 65 000 in total.

The final draw will be held in Q1 2015. In the final instalment of the contest, a Mercedes C200 will be the grand prize.

POWELL INTERNATIONAL

We Make Shafts RIGHT

- Supply of PTO shafts & universal joints
- Supply of brand new OEM / Aftermarket shaft for continental / Japanese trucks (base on part / chassis number)
- Repair & service of cordon shaft



GKN > **GKN LAND SYSTEMS** Authorise Dealer
Approve propshaft workshop for Service and repair

No. 38 Loyang Drive, Singapore 508960
fax: 6398 0995 email: sales@powell-shaft.com Please visit www.powell-shaft.com

Nothing fancy. Nothing complicated.
Just the authorized Sinotruk workshop in Kuantan



BAKTICON ENGINEERING SDN BHD
(560357 - M)



MOHD ZAID B. ABDULLAH
Managing Director

mohdzaid.bakticon@gmail.com

Terengganu & Pahang
Bakticon Engineering Sdn Bhd
Lot 4262, Jalan Kuantan -
Pelabuhan. Seberang Balok,
26100 Kuantan Pahang.
24 Hrs Assistance No:
+6019-2412958



www.e-response.biz

Reduce operating costs – and save lives!



Effective Heavy Bus and Truck Driver Training is known to greatly reduce operating costs.

E-Response Alert Sdn Bhd offers, we believe, the Best Advanced Heavy vehicle driver training in Malaysia. The course is endorsed by the Chemical Industry Council of Malaysia (CICM) and is internationally accredited by the UK's IMI Awards. It's a tried and tested 2 day Competency based training – not just a 'day in a classroom' – which has brought good results for companies like BP and Petronas.

With the expected de-regulation of the Malaysian Motor Insurance Industry, it's likely that those that have invested in effective training will pay reduced premiums.

To find out how we can help you improve driver morale and increase safety through the use of defensive driving - call us at 03 772 57148.

The Training is rated as SBL Khas Category and, as such, Funds can be directly drawn from a Clients Account

Tel (Office): +60 3 7725 7151 Fax (Office): +60 3 7725 7148

E-Response Trading Sdn Bhd
D-2-12, Blok D, Ritze Perdana,
No.5, Jalan PJU 8/2, Damansara Perdana,
47820 Petaling Jaya,
Selangor Darul Ehsan,
Malaysia

KELTRUCK

SCANIA
RECYCLED
PARTS

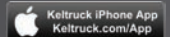

Buy online - keltruck.com/shop

ENGINES • GEARBOXES • AXLES • CABS
TAIL LIFT PARTS

PLUS A FULL RANGE OF COMPONENTS...



" WE EXPORT FROM THE UK TO
ANY PORT WORLDWIDE "

+44 (0) 121 524 1875



www.keltruck.com

T: +44 (0) 121 524 1875 E: usedparts@keltruck.com W: keltruck.com/usedparts

GPS Recorder with Real-Time Tracking

Intelligent Systems for Monitoring, Analysis and Control

Monitor and tracking on website / smart phone device.



GPS软件可用于
iPhone, iOS和Android
智能手机。



Other reports:
还有其它报告

Vehicle Usage Report, Geo-Fence Report By Place, Geo-Fence Report By Vehicle
Mileage Details Report, Planned Mileage Report, Stay Detail Report, Idling Overview
Road Plan Report, Speed Chart Report, Overspeed Chart Report etc.

GPS Features

- GPS+GSM+GPRS network
- Built-in high sensitive GPS chipset
- Built-in GSM&GPS antenna
- Real-time tracking and upload location information
- Relay for tele-cut off fuel/power
- Built-in acceleration sensor for vibration alarm
- ACC detection and upload vehicle status
- Built-in ON/OFF power, wide input voltage range
- Built-in 450mAh battery for alarm when power supply is disconnected unexpectedly
- Access location information via SMS or GPRS(TCP)
- External MIC for voice monitoring
- External SOS button for emergency alarm
- Built-in CPU, eliminating breakdown automatically
- Three LED indicators for displaying working status
- Check location via platform

FREE Demo at : www.gps.net.my

explosoft® International Sdn.Bhd. (618452-M)

No. 87-3, Jalan Metro Perdana Barat 1, Taman Usahawan 52100 Kepong, Kuala Lumpur, Malaysia.
Tel : +603-6250 8080 Fax : +603-6730 8402 Customer Care Line : 1700 801 801 Email: info@explosoft.cc

Built to be tough.



Pictures shown are for illustration purposes only and does not necessarily depict the specifications and offerings available in Malaysia.

Driving in construction, mining and forestry operations where you are required to go off road requires skill. Great skill when it comes to efficient and fast transporting of large loads without getting bogged down, and without compromising the truck.

But does it require muscles, too? No, not really. The Volvo FMX is robust and developed to make driving construction applications easier and safer - from the sturdy bumper and advanced steering to the new comfortable rear suspension. Let us show you what a modern construction truck, packed with innovative solutions and groundbreaking features, looks like.

For more information, call Customer Care Centre 03-5510 3300 or log onto www.volvotrucks.com.my

Follow us!  facebook.com/VolvoTrucksMalaysia

THE NEW VOLVO FMX

Volvo Trucks. Driving Progress

